



Fox Delta

Amateur Radio
Projects & Kits

SWR ANALYZER

User Guide

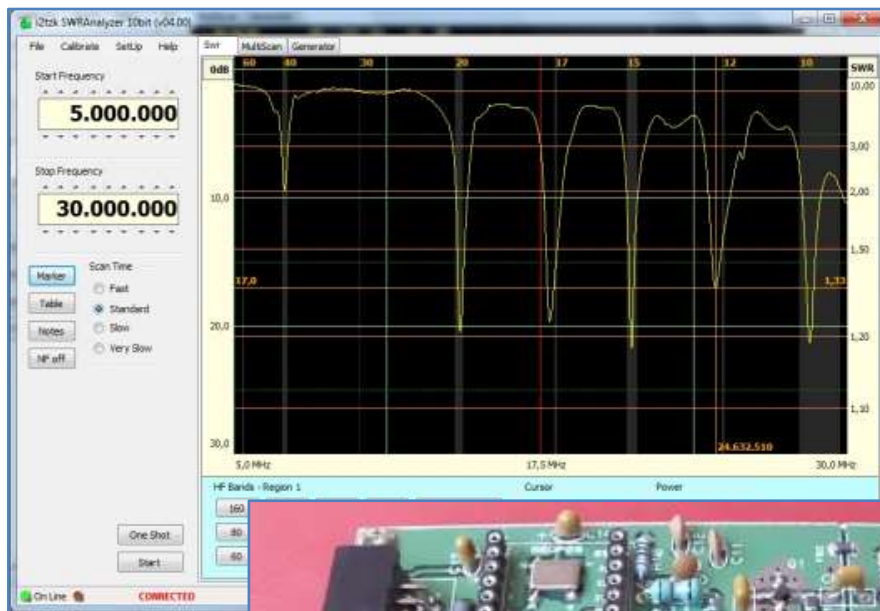

December, 2014

Index

1	Project genesis	4
2	SWR Analyzer project's notes	5
3	Connecting the Hardware.....	8
4	Launching the PC program.....	10
5	General Calibration.....	11
5.1	RL Bridge Calibration.....	12
5.2	Frequency Generator	15
6	Exploring the antenna's resonance	16
6.1	IARU HF Band Limits.....	18
6.2	Data at cursor position.....	19
6.3	Resonance analysis	20
6.4	Markers	21
6.5	Data Table	23
6.6	Noise filter.....	24
7	Comparing graphic plots.....	25
8	Printing, exporting and importing data for analysis.....	26
8.1	Print a Graphic.....	27
8.2	Print the Data Table	29
8.3	Export graphic as a picture	30
8.4	Export Data Table	31
8.5	Import Data from SWRA board	33
8.6	Import Data from a CSV File	34
9	Signal Generator.....	36
10	Special Applications.....	38
10.1	Characterizing a 50 ohm Filter.....	38
10.2	Matching the Antenna Tuner to the Antenna	41
10.3	Data gateway.....	42
11	Firmware update.....	43
11.1	The updating procedure	44
12	Hardware implementation	48
12.1	DDS.....	49
12.2	Led.....	49
13	SetUp Procedures.....	50
13.1	SWR and Return Loss Scaling.....	50
13.2	Open/Short ratio check of the RL Bridge	51
13.3	Checking the RL Bridge accuracy	52

13.4	RL Bridge minor calibration adjustments	54
14	Optional add-on	55
14.1	Bluetooth module	56
14.2	GLCD for stand-alone operations	57
15	Help menu.....	59

1 Project genesis

I enjoy experimenting with antennas, developing new solutions, constructing the antennas and then testing them, but this entails being able to accurately measure the antennas characteristics such as SWR and reactance at a number of frequencies that need to be plotted as graphs or printed out in tabular form to analyze the overall performance.

Ideally, to do this type of analysis a professional VNA (Vector Network Analyzer) would be required or a similar device designed for amateur radio, that provides SWR and impedance readings for different frequencies.

There are quite a few excellent products on the market that are suitable for the Ham Radio, such the "miniVNA" (www.miniradiosolutions.com), the "SARK100" (www.ea4frb.eu) or the "VNA 1280" (www.arrayolutions.com) as well as several models of Antenna Analyzer like the MFJ's product family (www.mfjenterprises.com) or the RigExpert (www.rigexpert.com) etc. etc. More recently, there is the MAX6 VNA designed by Jarek SP3SWJ.

The cost of these instruments varies according to their frequency ranges and type of displays, with prices ranging from \$100 to over \$400. However for some time now, I had an idea that it should be possible to design an HF instrument that was ***simple and easy to use with a desktop PC or laptop running dedicated software. BY restricting the frequency range and by only measuring SWR the hardware could be further simplified to reduce costs.***

This idea became a project after I got in touch with Dinesh, VU2FD and Frank, K7SFN. Dinesh offered to take care of the hardware logistics, Frank offered to test hardware and software that I would develop along with the necessary measuring interface firmware and associated Windows based software.

What started as a simple idea became reality and the **SWR Analyzer** project continues to evolve.

Tony, I2TZK

SWR Analyzer's main features:

- Smart and very cheap hardware implementation
- Free firmware and software for the Ham Radio Community
- USB connection to the PC
- HF bands for each IARU Region highlighted
- Plots of SWR in any HF Band
- Measuring Cursor indicates SWR & dB Return Loss anywhere on a trace
- Compare 3 SWR traces on a single graph
- RF generator from 1MHz to 35MHz & combined SWR measurement
- Export data in CSV (comma Separated Variable) format & graphs as PNG BMP JPEG
- Print graphics and data table
- Return Loss Bridge: directivity > 40dB, open/short ratio < 1dB

2 SWR Analyzer project's notes

The "SWR Analyzer" is a smart, cheap and easy to assemble design.

The project is focused on measuring the antenna SWR performances across all the HF Ham radio bands without any need for the transmitter to be connected to the antenna.

The "SWR Analyzer" is a *Scalar (or single port) Network Analyzer*, the following figure shows the hardware architecture.

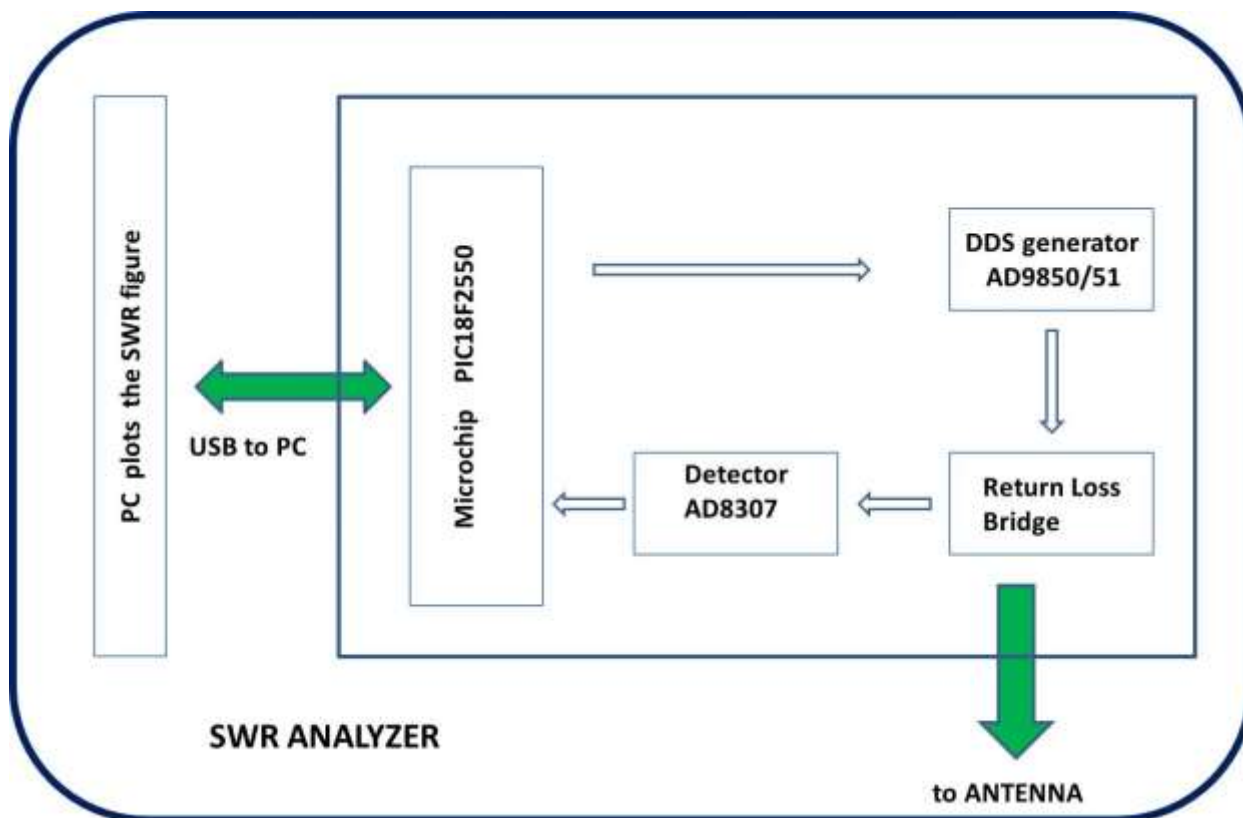

The main elements of the diagram are:

- **Microcontroller PIC18F2550**
- **DDS (Direct Digital Synthesis) generator AD9850 / AD9851**
- **Return Loss Bridge (50 Ohms)**
- **Detector AD8307**

The microcontroller PIC18F2550 is used, the software identify the firmware version automatically and interfaces the PC receiving commands to drive a RF generator (DDS) and returning the voltage values measured by the 50m ohms Return Loss Bridge back to the PC.

The Analog Devices AD9851 is a Direct Digital Synthesizer (DDS) device can generate a sinusoidal wave up to 180MHz or 125MHz if the AD9850 is used. The microcontroller makes the DDS generate frequencies between 1.0 MHz – 50 MHz to sweep the whole of HF band in discrete (user configurable) steps, feeding one end of the Return Loss Bridge. The software allows the user to select the HF band to be swept or to specify the start and stop frequencies of the sweep.

The RLB (return loss bridge) is a wideband resistive bridge network used to verify the impedance at the antenna connector. It works by comparing the "unknown" antenna impedance to a purely resistive 50 ohms, the output DC voltage corresponds to the degree of impedance mismatch between the 50 ohms and the antenna impedance.

Generally speaking, the higher the DC voltage output, the worst the impedance mismatch is.



The RLB's output voltage is fed to the AD8307 (configured as detector/differential comparator), which amplifies the signal level, and converts it to a dB (decibel) level that is fed to the microcontroller.

The ADC (Analog to Digital Converter) embedded into the microcontroller digitized the voltages and sends this to the PC for further processing.

Finally the Windows based PC program calculates the dB values, translates the measurement into a SWR value that is then plotted in the graph area of the display.

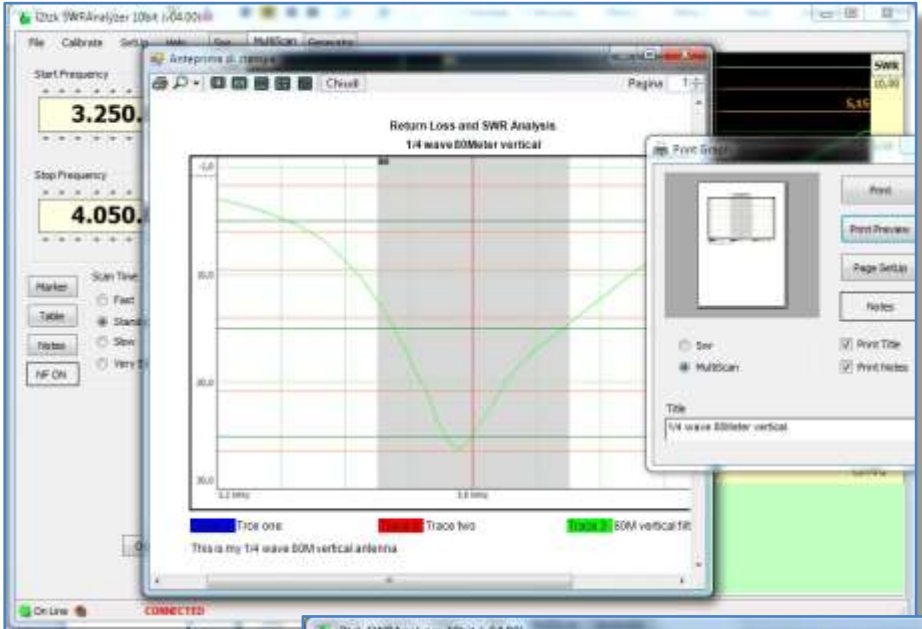

The software enables the user to explore a single HF Band or the full range from 1 to 50MHz on the monitor screen as shown below, or a printed out on paper or save as a PDF or image file (shown on the left) with a title and notes of the investigation for a record to refer to at a later date.

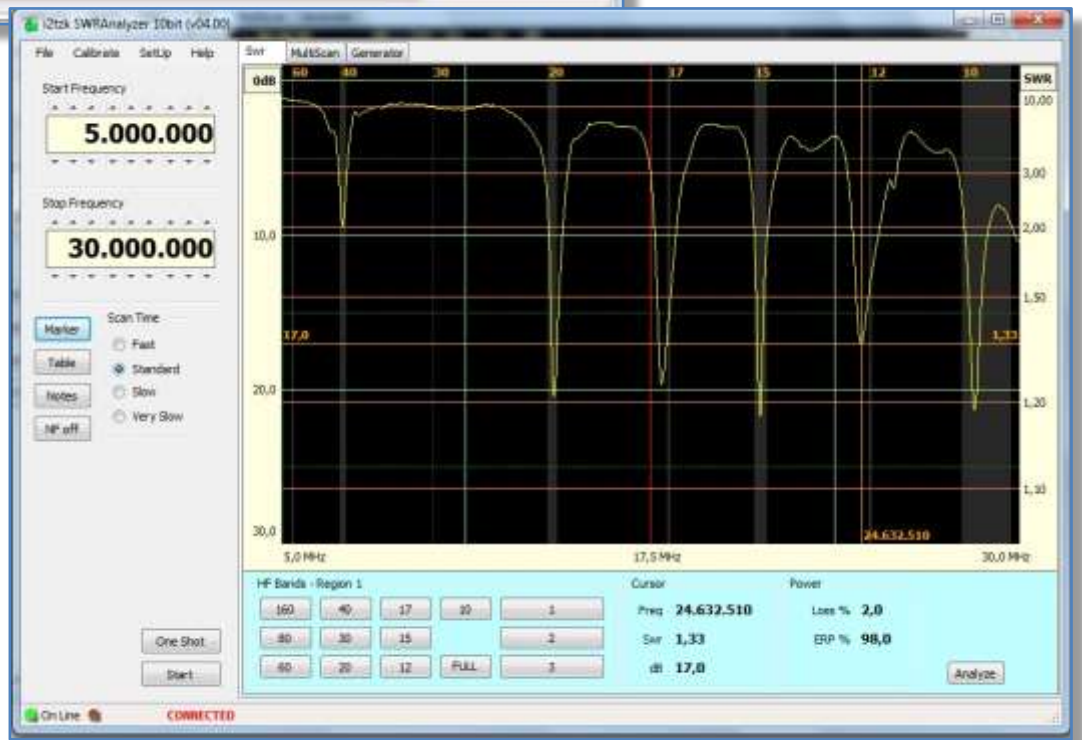

3 Connecting the Hardware

Connect the SWR Analyzer Unit to the PC or Laptop using a standard USB cable (printer cable), **after a while the white LED close to the BNC connector will glow indicating** that the board is ready to be linked by the PC Analyzer software.

If this is the first time you attach this SWR Analyzer, Windows will start to search for and install the required drivers. To communicate with Windows, the SWR Analyzer uses the USB port embedded into the microcontroller PIC18F2550. The **drivers are the standard ones developed by Microchip and Windows Microsoft.**

Windows is searching the driver



The PC will sound an alert to indicate a new device has been detected and the corresponding driver is loading.

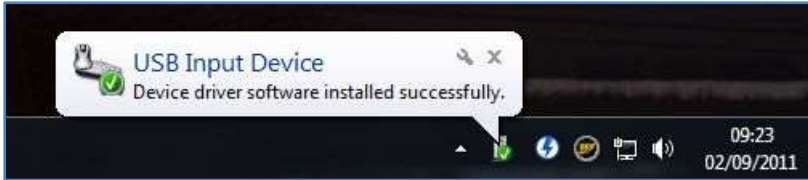

Driver successfully found and installed

Usually this happens only once, next time you connect the SWR Analyzer all needed parameters are already know by Windows.

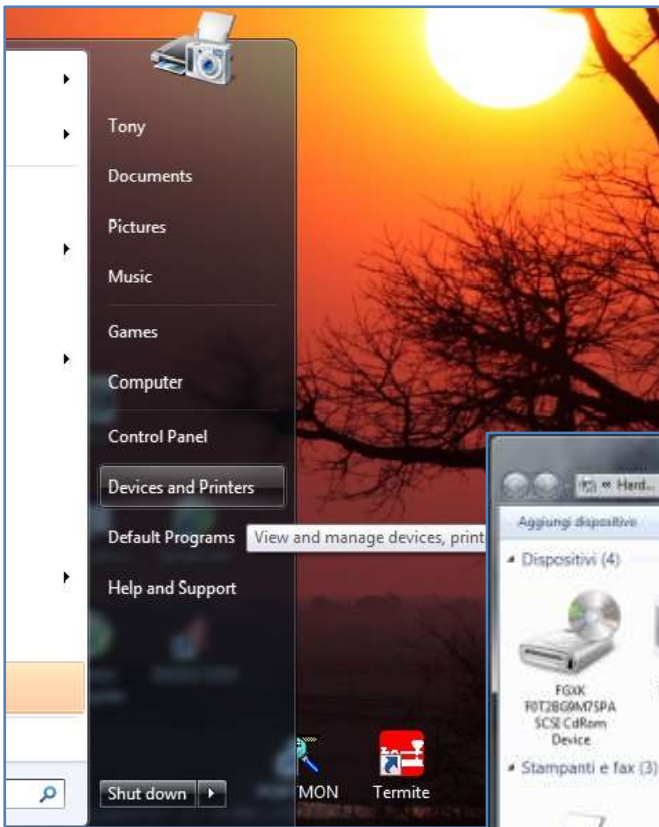

To check is the driver has installed correctly, select “Device and Printers” from the “Start” menu (Windows 7) or from the “Control Panel”

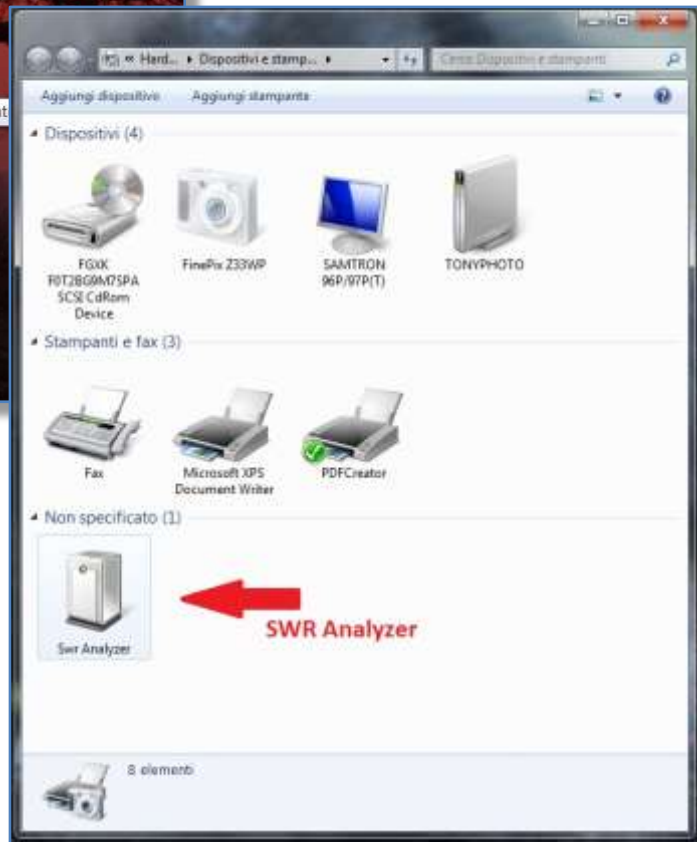

4 Launching the PC program

The software application doesn't need any installation procedure, simply create a new folder. The Zip file "SWRAnalyzer vx.xx.zip" is downloaded from <http://www.i2tzk.com> and the contents extracted to the new folder .

To launch the program, navigate to this folder and DoubleClick "SWRAnalyzer.exe".

For your convenience you can create a link to the desktop right clicking on "SWR Analyzer.exe" and selecting "Send to Desktop".

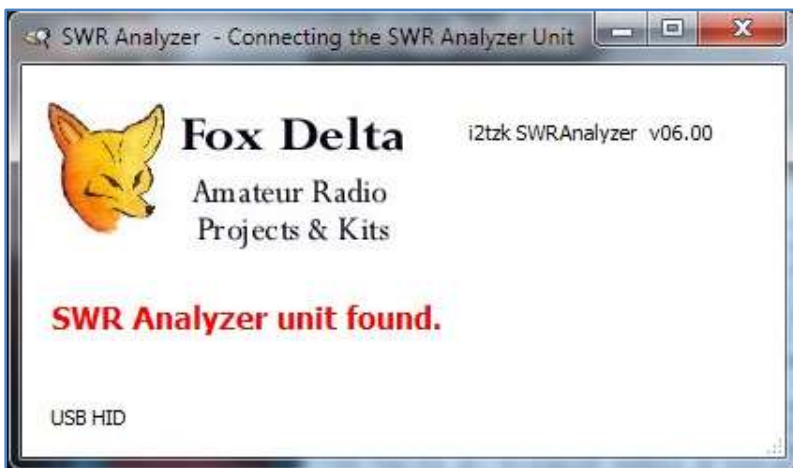

When program starts, it automatically searches for the SWR Analyzer board exploring all the USB devices.

When the Analyzer unit is discovered by the software the **white LED** next to the BCN connector starts blinking and the message "**CONNECTED**" appears on main screen as show in the figure on the right.

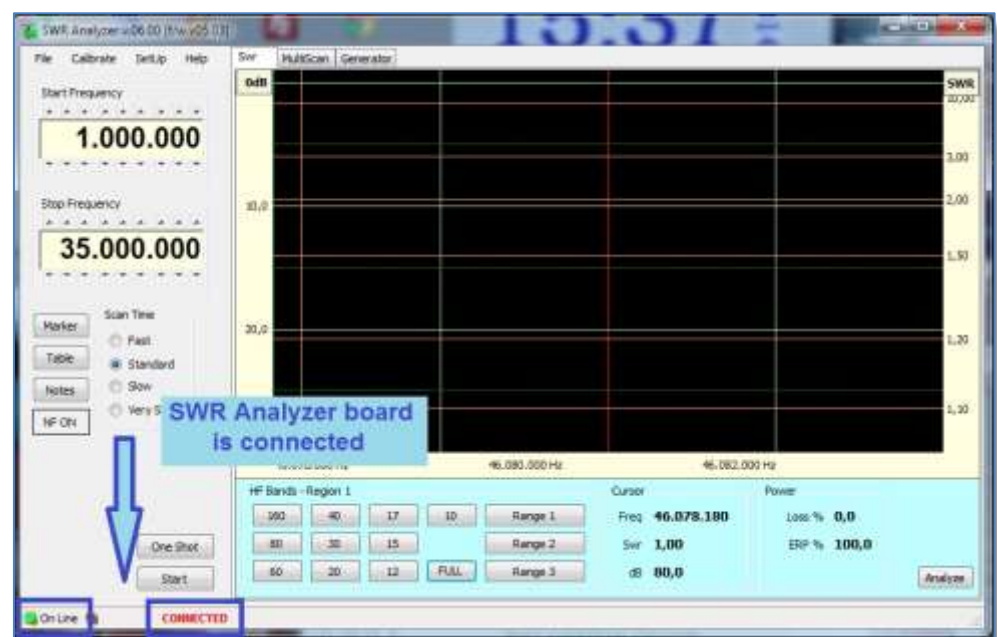

5 General Calibration

First time the “SWR Analyzer” software runs, a request to calibrate the hardware appears. Command from Windows menu bar: **[Calibration]**.

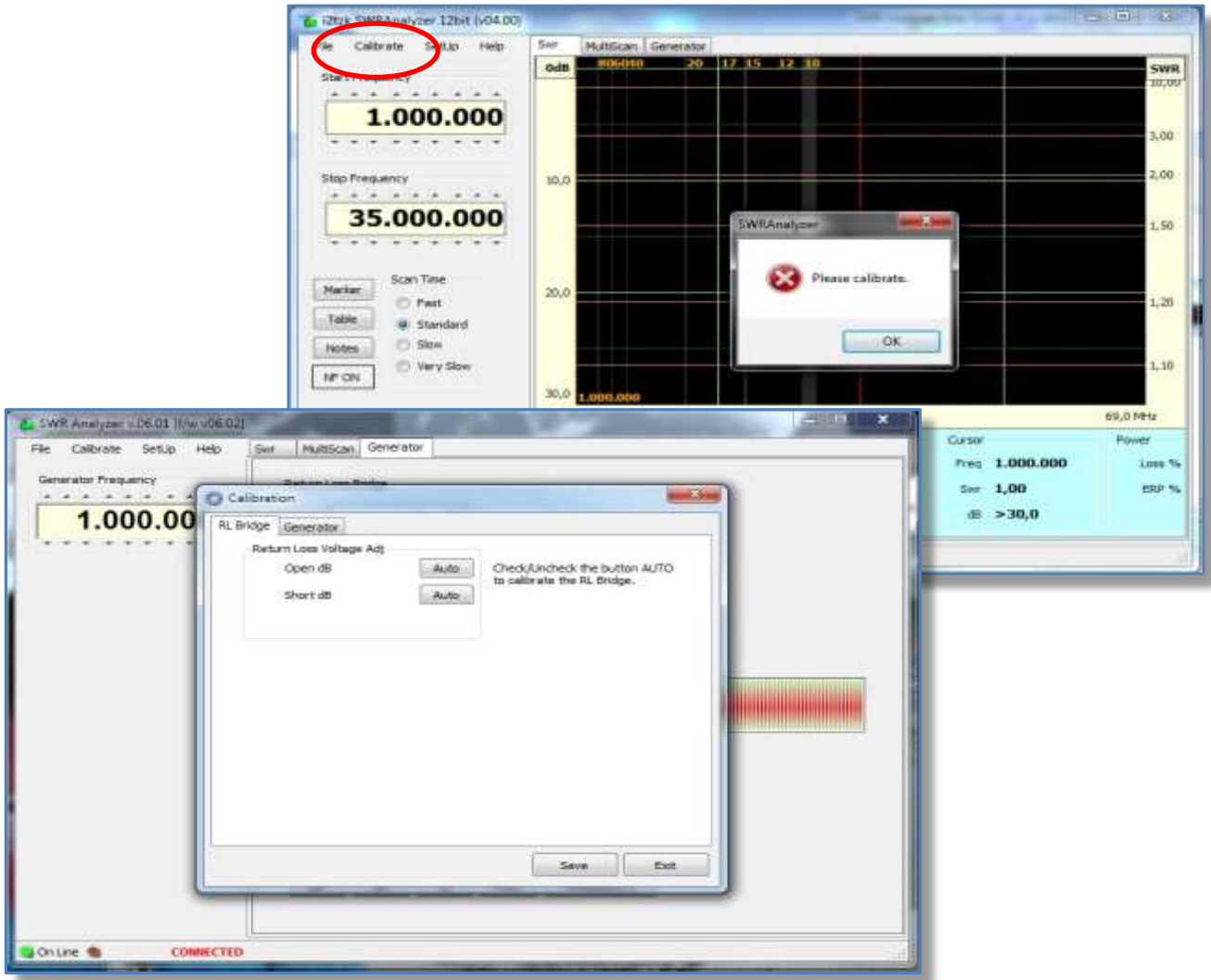

The Calibration window also has a Generator Tab, where the oscillator frequency can be fine-tuned using a calibrated frequency counter connected to the BNC connector. ***This adjustment is not necessary for standard operations.***

The bridge calibration requires two simple steps: a calibration of the BNC connector with an Open and Short circuit (a paper clip cut in half could be a convenient way to create the short circuit).

5.1 RL Bridge Calibration

Connect the SWR Analyzer to the PC USB port, run the SWR Analyzer software, from the Windows menu bar at the top of the screen and select the **[Calibrate]** tab to open a pop-up window on the **[RL Bridge]** tab.

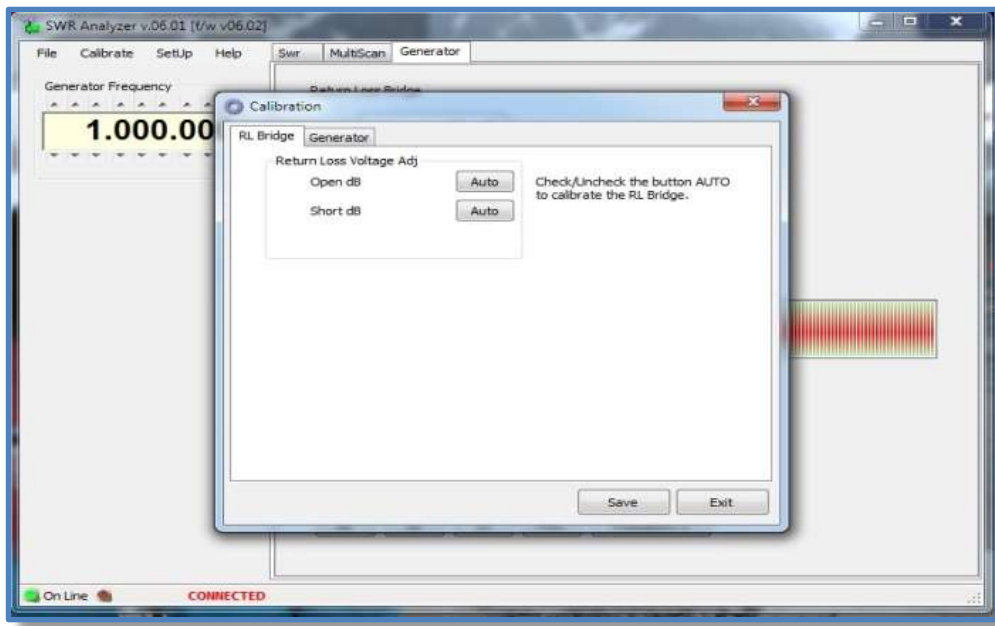

The simple calibration process requires just **2 steps**: Calibration **Open** and **Short** circuit.

- **Open circuit** means that the Antenna BNC connector must be left open, no cable, dummy load or any other device connected.
- **Short circuit** requires that the Antenna connector is 0 Ohms terminator.

STEP 1 :

Ensure that **NO cable is plugged** into the Antenna connector and do not interrupt or unplug the USB cable during this process.

Click on **[Auto]** button next to the field “Open Circuit” and **[Start]** to start the first stage of the calibration process.

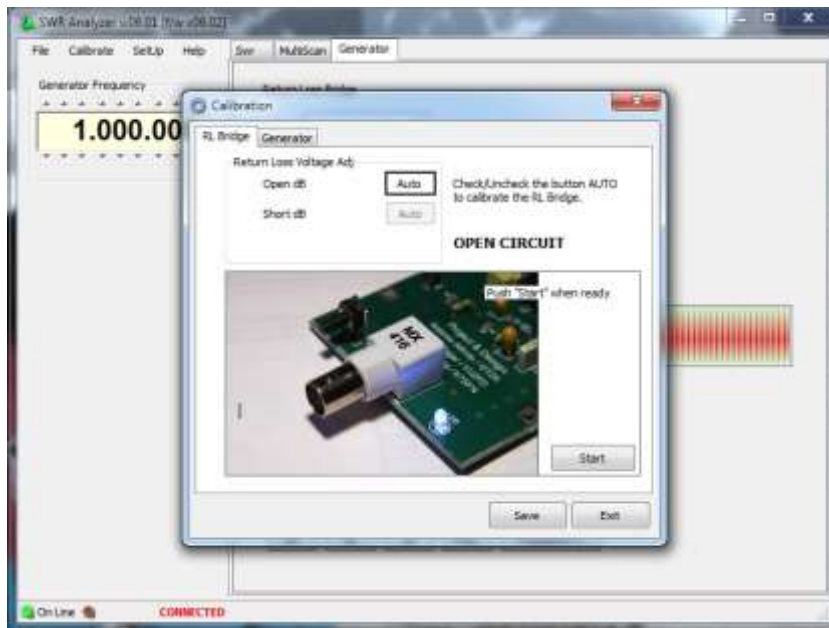

The screen will show the frequency incrementing in 1 MHz steps from 1.0 to 50 MHz.

When the “Open circuit” checks are successfully completed the button [Auto] turns **green** to indicate that this step has been successfully executed.

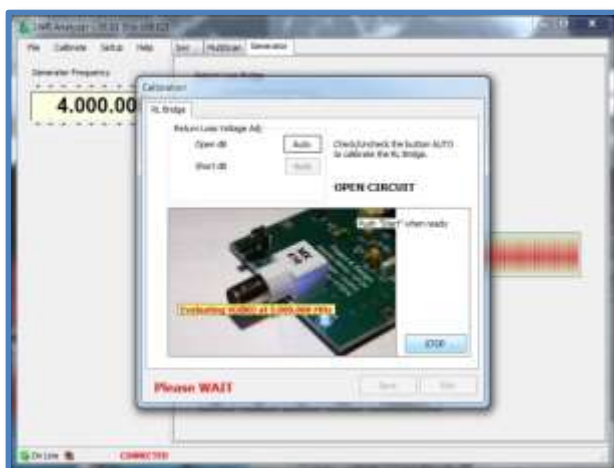

STEP 2 :

Now connect a *0 Ohm terminator* to the Antenna BNC socket and click on the second **[Auto]** and **[Start]** to start the second calibration step. Similarly to the first step the generator will sweep through the frequencies during this process.

Once the process has completed the second **[Auto]** button will turn to *green* to indicate that this step has been successfully executed.

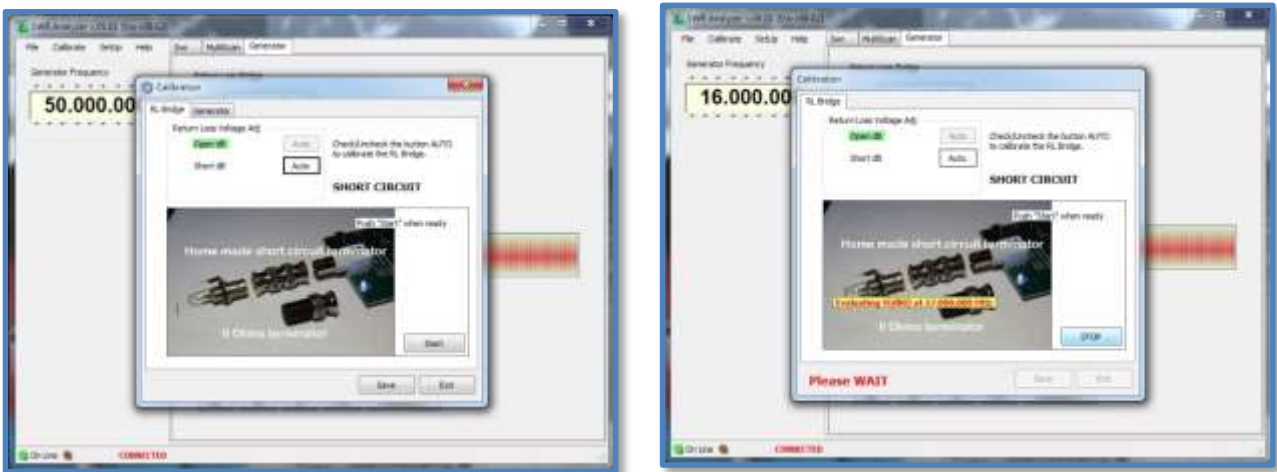

Finally, **[Save]** the calibration data and restart the program. The Program will remember the calibration details and will use this every time you connect the Analyzer to the PC's USB port

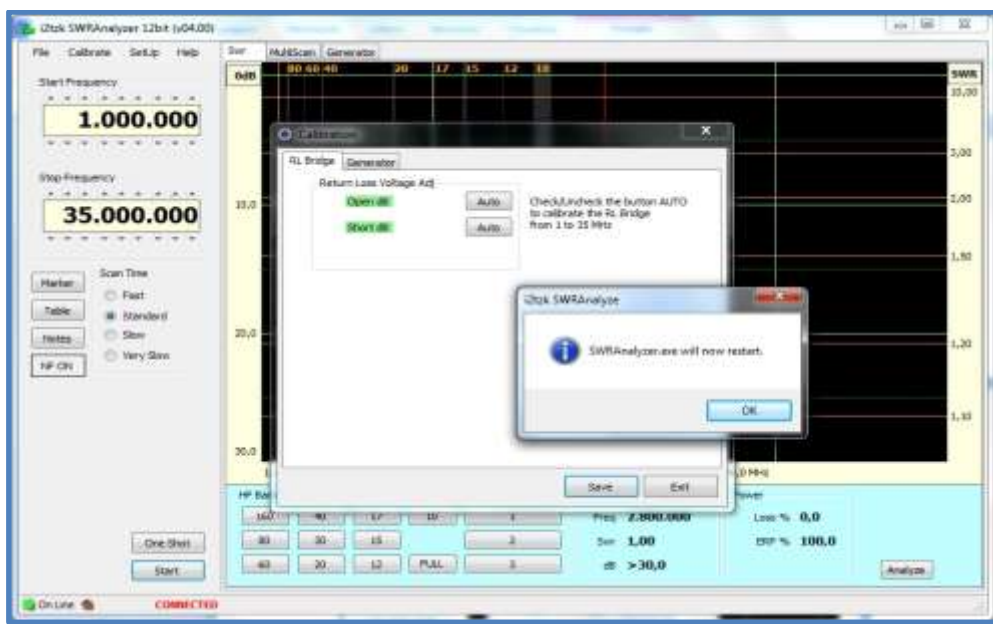

5.2 Frequency Generator

The DDS Generator uses a crystal oscillator for its clock source. The frequency generated is very stable and precise, *generally no further adjustment will be necessary*, nevertheless it is possible to fine tune this using a calibrated frequency counter with a resolution of at least 0.1Hz at 10MHz.

Connect the Analyzer BNC output to the frequency meter as shown below

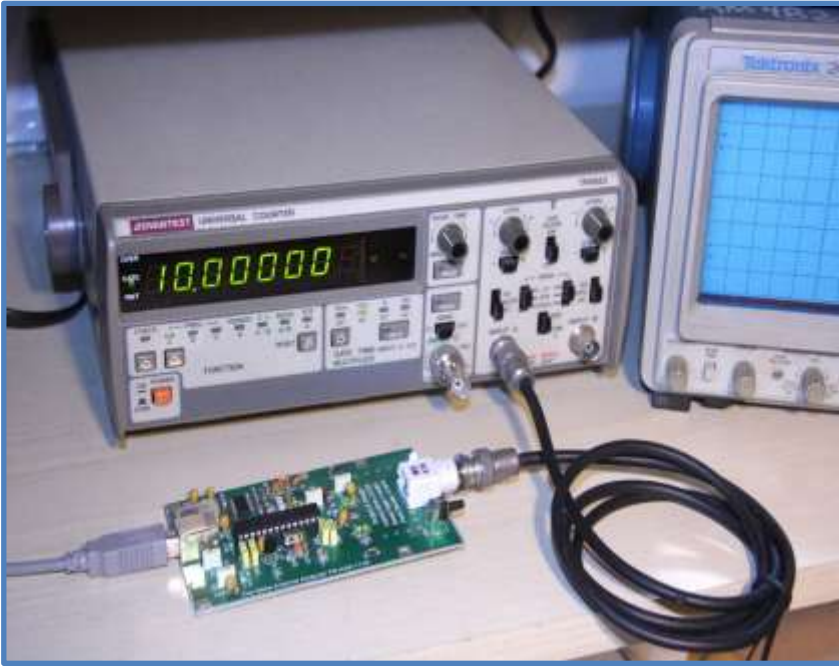

On the Windows menu bar select the **[Calibrate]** tab to open a pop-up window. In the new window select the second tab **[Generator]**.

The “Generator” is automatically selected and his frequency set to 10.000.000 MHz.

Use the [+] or [-] Buttons to adjust the DDS generator until the frequency counter shows a frequency very close to 10MHz.

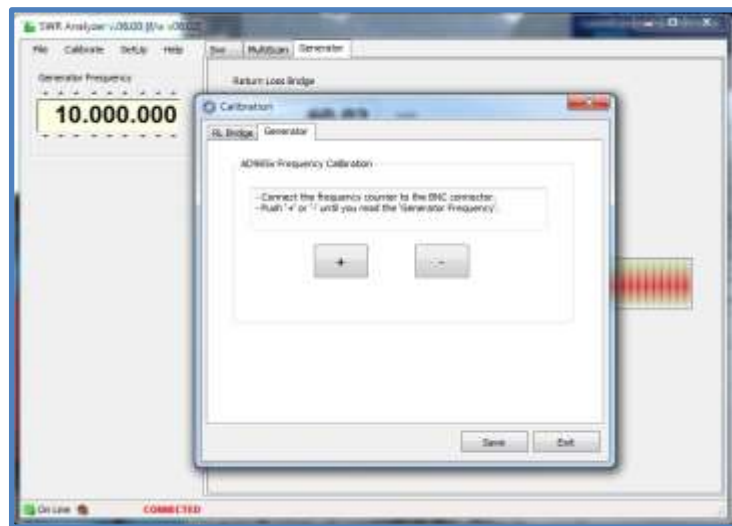

6 Exploring the antenna's resonance

Command from Widows menu bar: **[SWR]**. This will open the primary graphics screen with a set of HF band buttons underneath.

Select the specific IARU HF band or [FULL] to set the "START" and "STOP" frequencies. You can alter these later by clicking the thumbwheel controls.

For a continuous real time analysis press **[Start]** (useful while you are calibrating your antenna) the SWR figure will be refreshed a couple of time per second depending on the selected "Scan Time".

Press **[One Shot]** for a one time single static graphic.

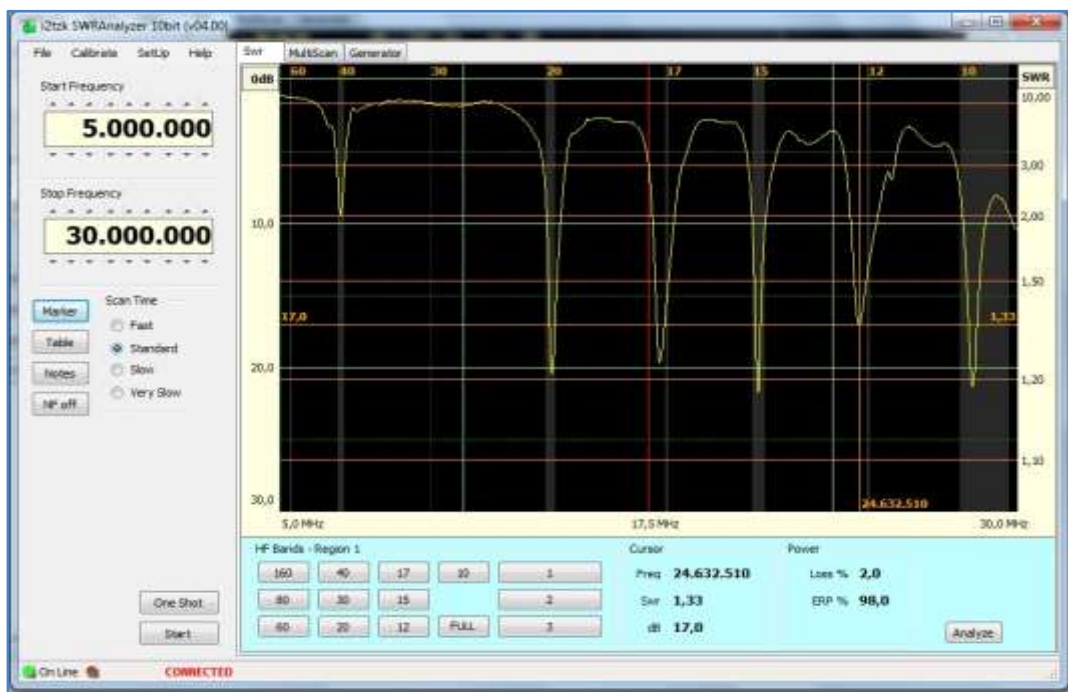

Three additional buttons labeled "Range 1" ... "Range 3" are available for pre-defining custom frequency ranges.

From the menu bar select **[SetUp]** and then in the new pop-up window select the **[Generator]** tab.

Define each of the three buttons by using the up/down arrows. The number boxes may be edited to show the names (12 characters) of each button e.g. button 1 could be named "40m-30m"

[Save] and restart at the end.

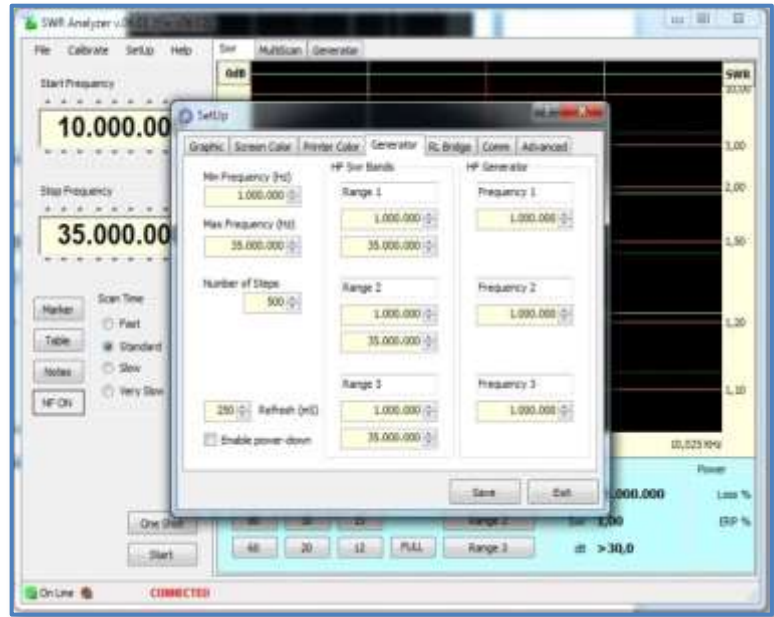

The **[SetUp] [Generator]** tab also allows you to change the min and max frequencies as the overall range the DDS is required to work over. **By default the range is 1.0 to 35 MHz** to overlap the whole of the HF bands slightly. Change the max frequency if you want to explore the 6m band too.

6.1 IARU HF Band Limits

HF bands are marked with opaque grey vertical bands. These help in highlighting how close the SWR minimums are to the band edges. The figure below shows all the band markers on the [FULL] frequency scan.

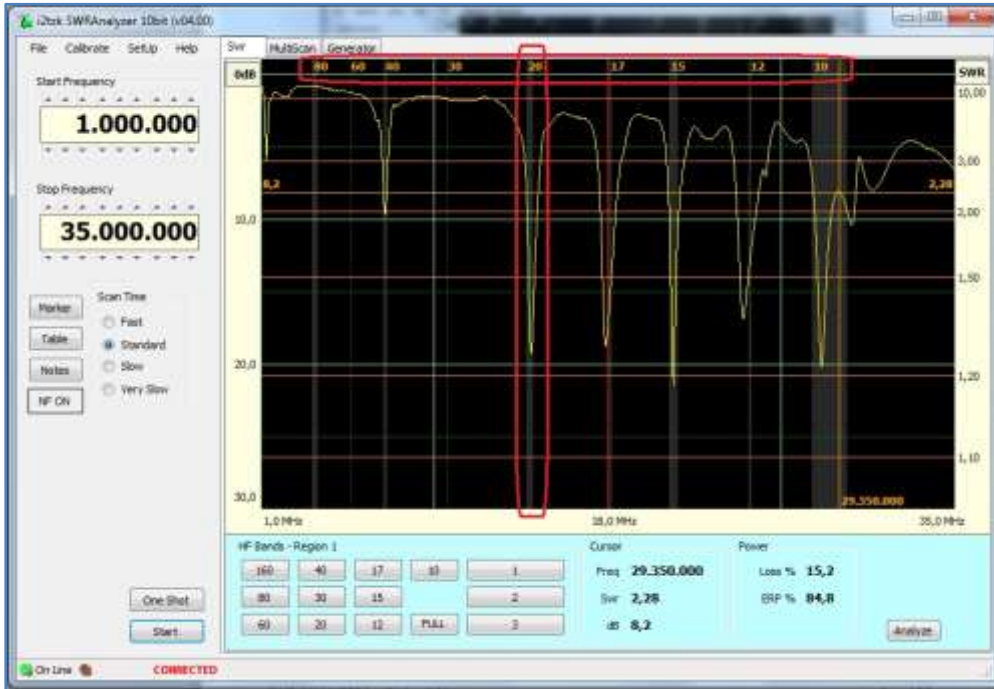

N.B.
The Band Markers band edges are IARU Region dependent.

To select the correct IARU Region, from the Windows menu bar select **[SetUp][Graphic]** this will bring up a new window where the IARU Region can be chosen.

The Marker can be turned off by unchecking the “show bands” box. Clicking the IARU up/down arrow select the regions 1-3.

“Scan edge KHz” allows you to set the amount of kHz spacing to the Stop Frequency.

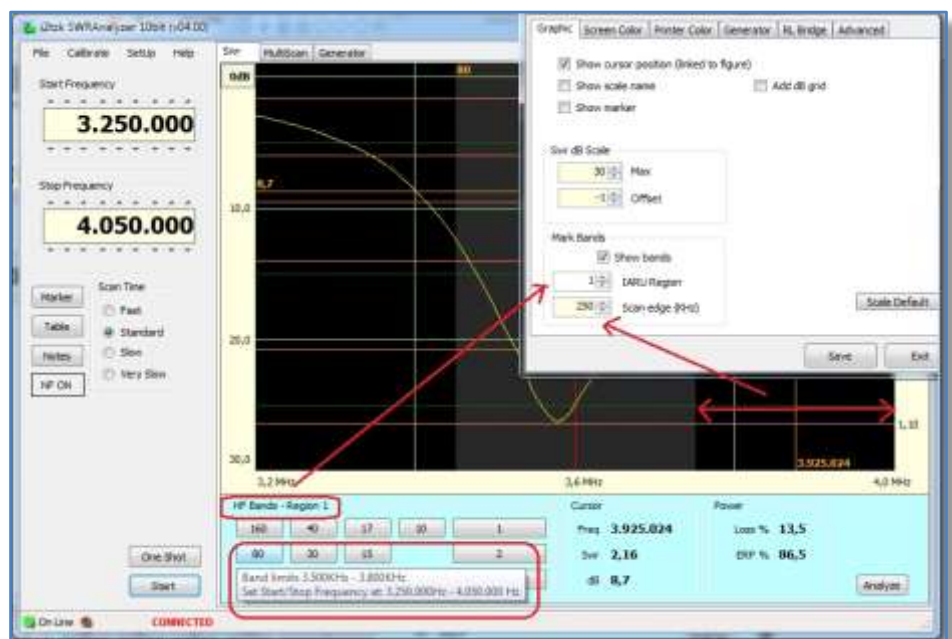

6.2 Data at cursor position

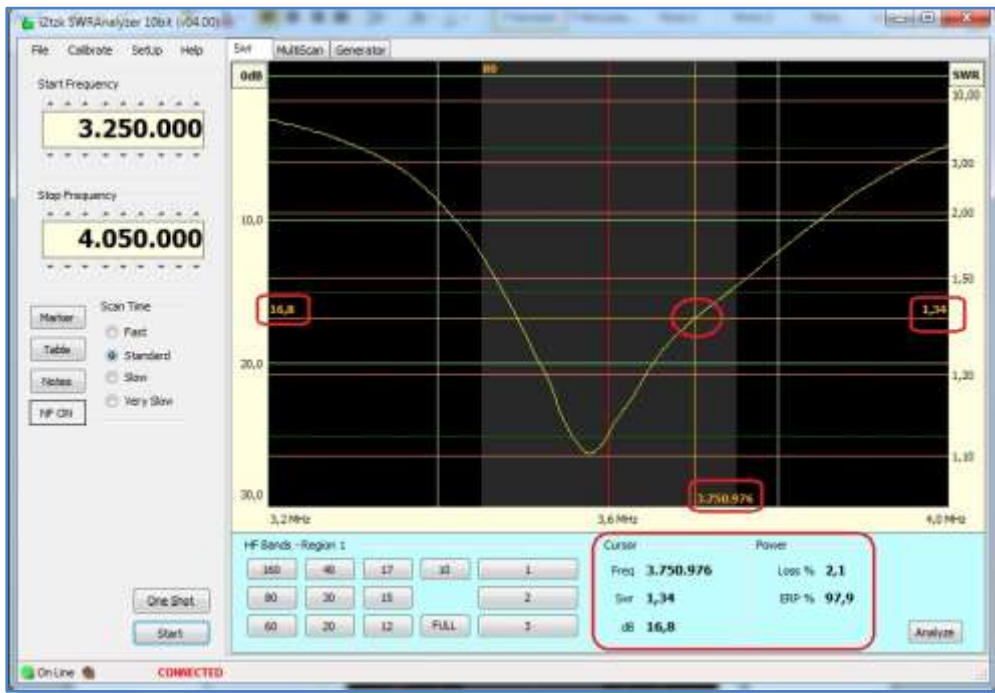

BY moving the mouse over the graphic, two lines (vertical and horizontal) will appear that follow the graphs curve and will continually display the measured values at any position the mouse stops at.

- frequency is shown in Hz, Return Loss in dB.
- power loss and ERP % (Effective Radiate Power) are also shown in a panel at the bottom of the screen.

6.3 Resonance analysis

The “Resonance Analysis” algorithm searches the graphs plotted values for the resonance dips, to activate this feature click on the **[Analyze]** button on SWR panel.

In the two figures shown below, at each dip in the plot, identified by a purple vertical line, the SWR, Return Loss, Bandwidth at SWR 1.5 and SWR 2.00 are calculated and displayed in the pop-up window.

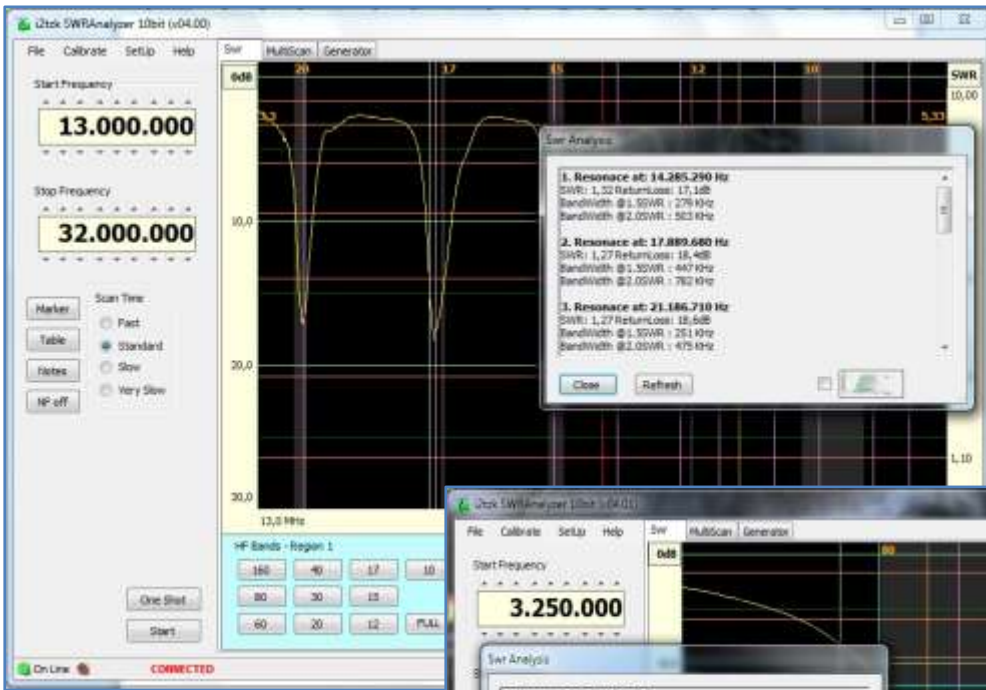

In this example the DUT (Device Under Test) is a band-pass filter. The Bandwidth @3dB and Q factor at center frequency have also been calculated and displayed in the window.

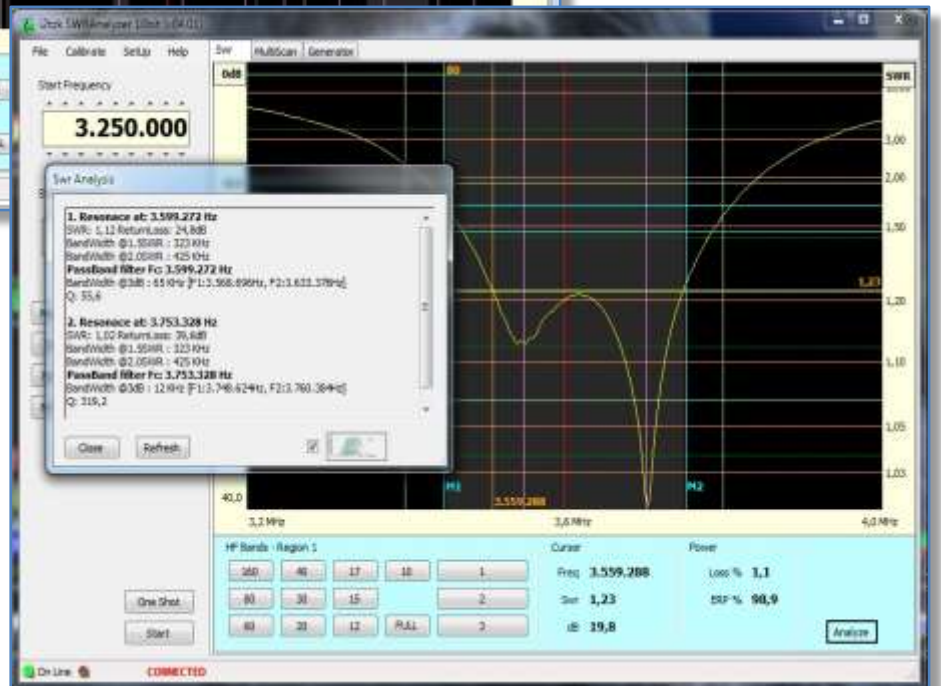

N.B In the current version of software the SWR Analysis window’s values cannot be printed out directly. However by using a screen grab [CTRL] [PrtScn] Cut & Paste [CTRL] V to insert this into a document a record can be made that you can print out later.

6.4 Markers

Four markers lines are available:

- Two vertical (M1 and M2)
- Two horizontal (M3 and M4)

Activate the markers clicking on the **[Marker]** button and checking the box [Show] on the small floating “Marker” pop-up window.

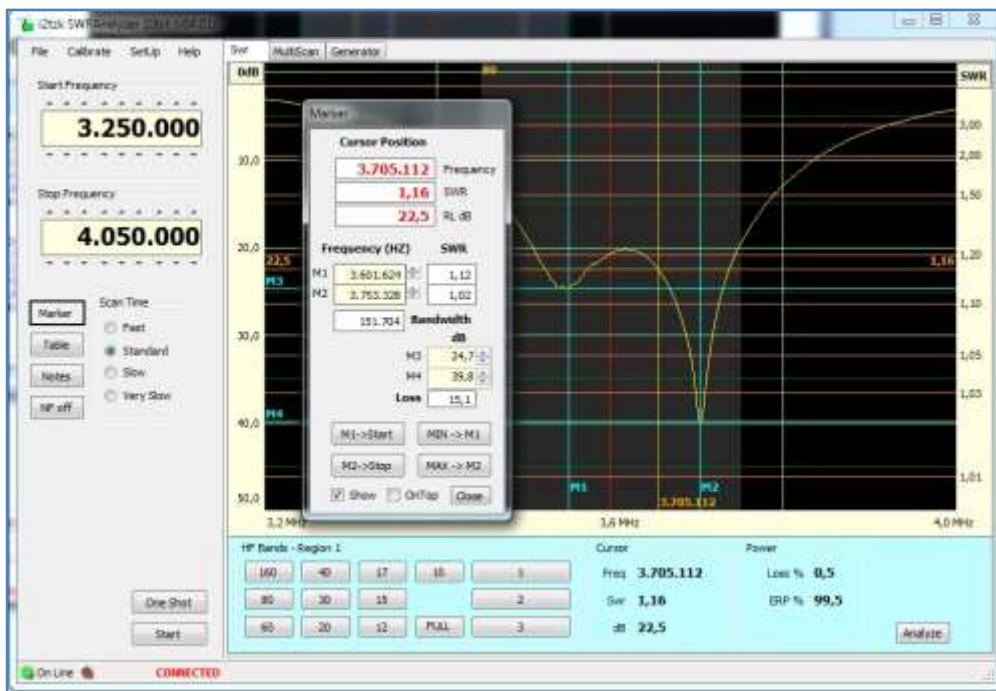

The four markers lines can be moved to specific places on the graph by using the mouse control buttons and keyboard.

- **Move M1 or M2 vertical markers** over the pointer position, do a **Right or left** click on the mouse button.
- **Move the horizontal marker M3 or M4** over the pointer position, do a **Ctrl+right and ctrl+left** click.
- Moves the M1/M3 or M2/M4 pair of line to SWR value closest to the pointer position, do a **Shift+right or shift+left** click

Markers can be used to highlight a specific point of interest on the graph that needs to be measured.

Markers positions are related to a fraction of the x or y axis i.e. not to frequency or return loss.

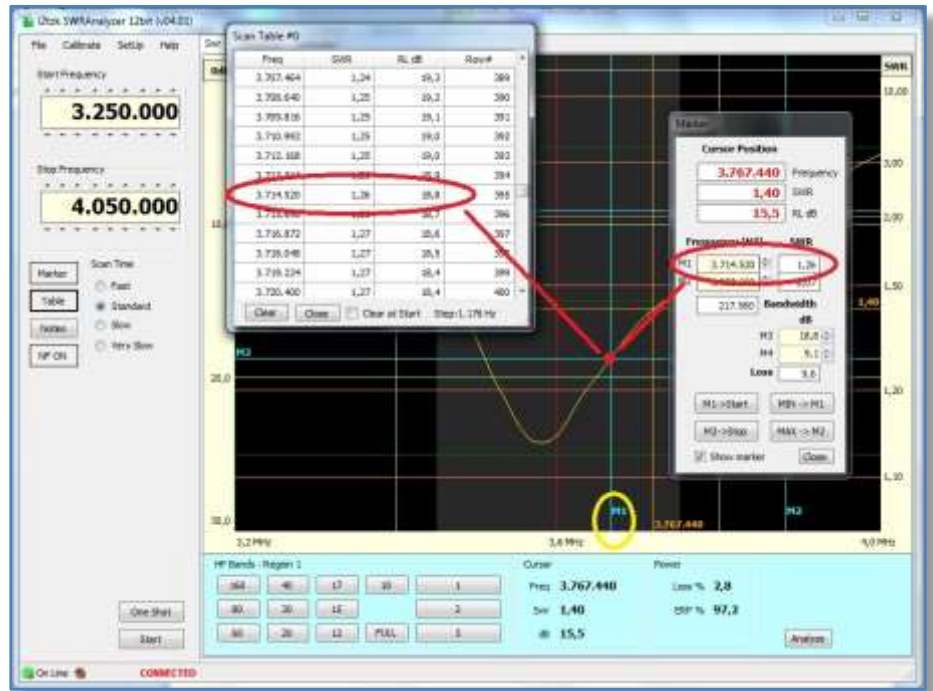

Marker thus remain in the same position even if the frequency setting or band changes.

Comparing the two figures, where the top figure covers the frequency range 3.2-4.0 MHz and lower figures frequency range is shortened to 3.6-4.0 MHz.

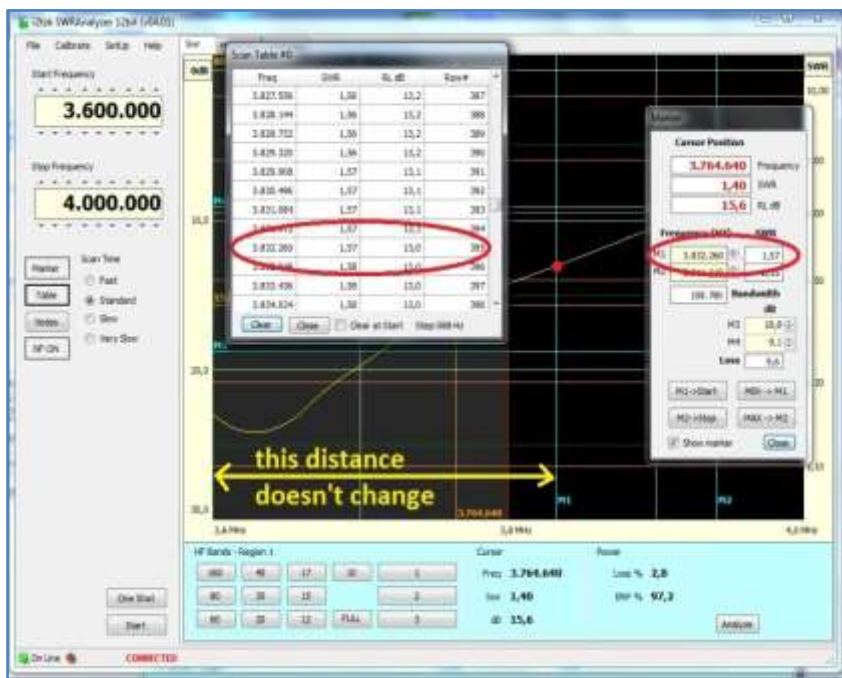

It can be seen that the values and the Scan Table & Marker windows reflect the measured values associated at the frequency, where the M1 marker intersects the graph, i.e. M1 marker is in the same position on the screen in both figures.

6.5 Data Table

The SWR Analysis is saved to the PC's memory as a Data Table, push the button **[Table]** to view the stored data. A floating pop-up window will appear as shown in the figure below.

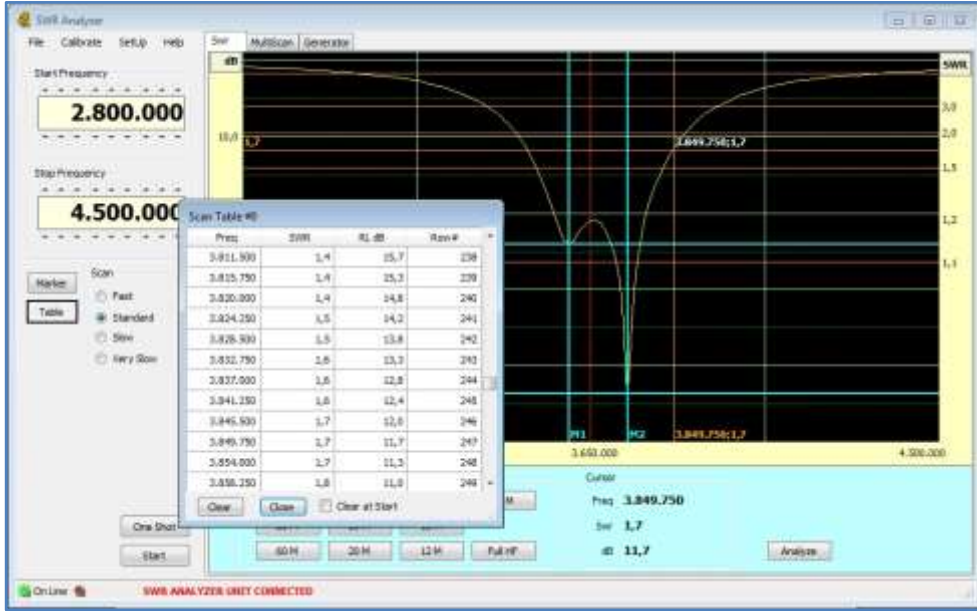

For a more detailed analysis the Data Table can be exported using the Windows menu bar **[File] [Export Data Table]** and then imported into any spread sheet as a CSV (Comma Separated variable) file e.g. MS Excel or other that can read the CSV format.

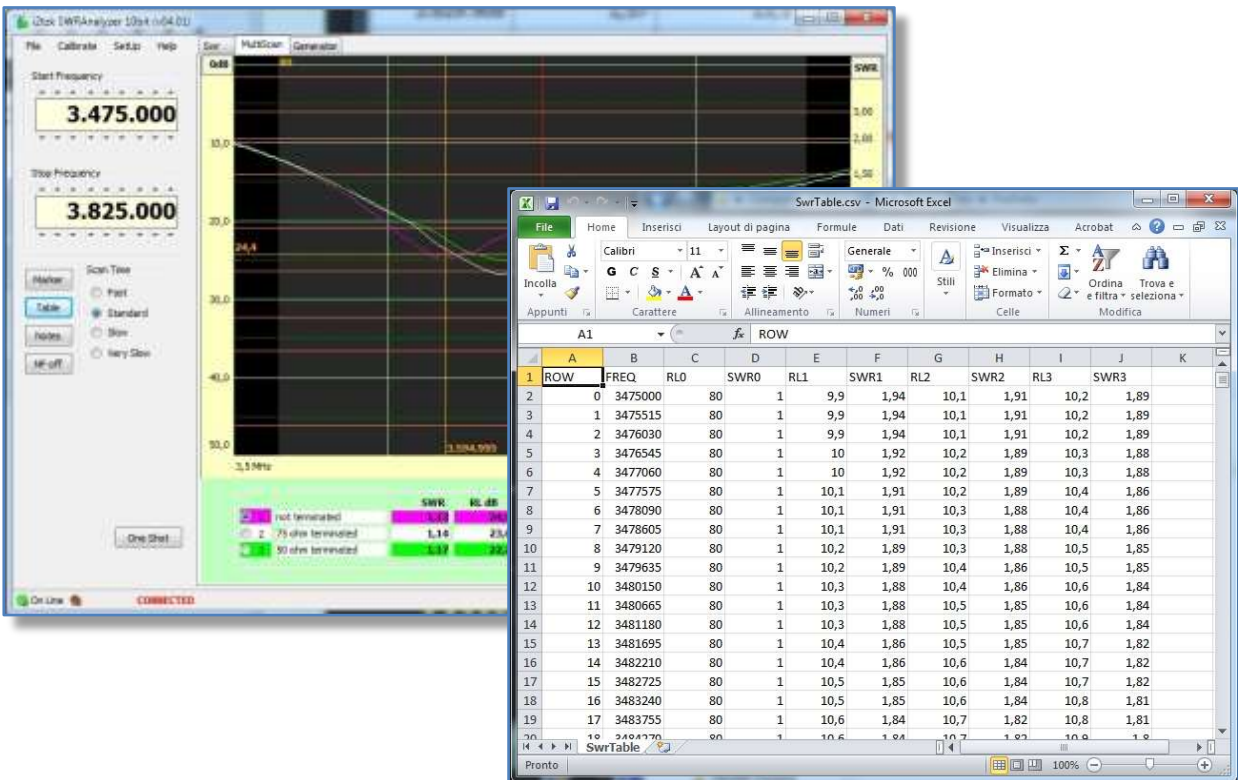

6.6 Noise filter

The Analyzer uses very low power to make the return loss measurements. The small forward and reflected voltages require a very sensitive wide-band amplifier chip for their detection. Occasionally the antenna may receive bursts of environment noise or powerful broadcast transmitters that can swamp the amplifier result in false readings.

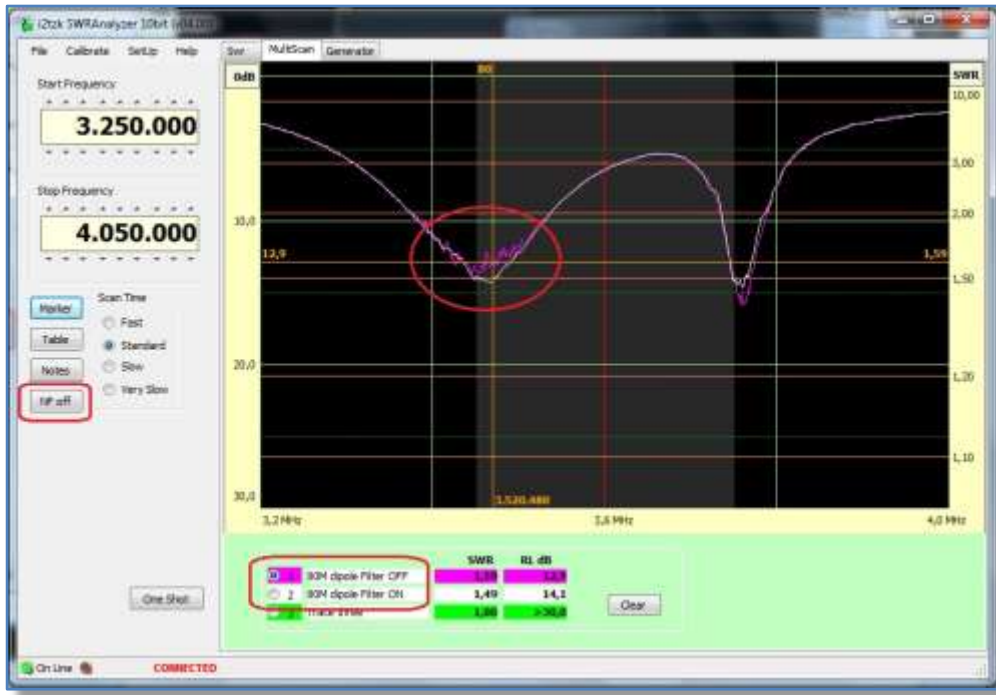

The figure has a red circle highlighting the effect of noise on the antenna return loss measurement.

- In these circumstances, the averaging noise filter may improve the results. Select the filter by clicking on the **[NF]** button on the left hand of the screen

The Filter averaging parameter can be changed by going to the [SetUp] on the menu bar and in the pop-up window selecting [RL Bridge]. By default, it is set to 100.

7 Comparing graphic plots

Command from Widows menu bar: **[MultiScan]**

The “MultiScan” screen has three channels, these allow you to compare up to 3 different plots in the same frequency band or user defined frequency range i.e. specific start & stop frequencies.

The three channels (1-3) can have a 20-character user defined name. To rename any of these, simply click on the area next to the number and type in the letters etc .

To use the MultiScan feature

- First, select the frequency range for the antenna return loss measurements. It may be easier to first go to the SWR screen and select a band button and then return to the MultiScan screen. You can then tailor the frequency to suit your needs by using the Start & Stop thumbwheels.
- Next, click on one of the channel number to select that channel, and start the scan by clicking on the **[One Shot]** button.
- When the scan completes select the next channel and click on the **[One Shot]** again.
- Select the next channel you require and repeat the steps above. When the new scan finishes you will see two traces on the graph and be able to compare them.

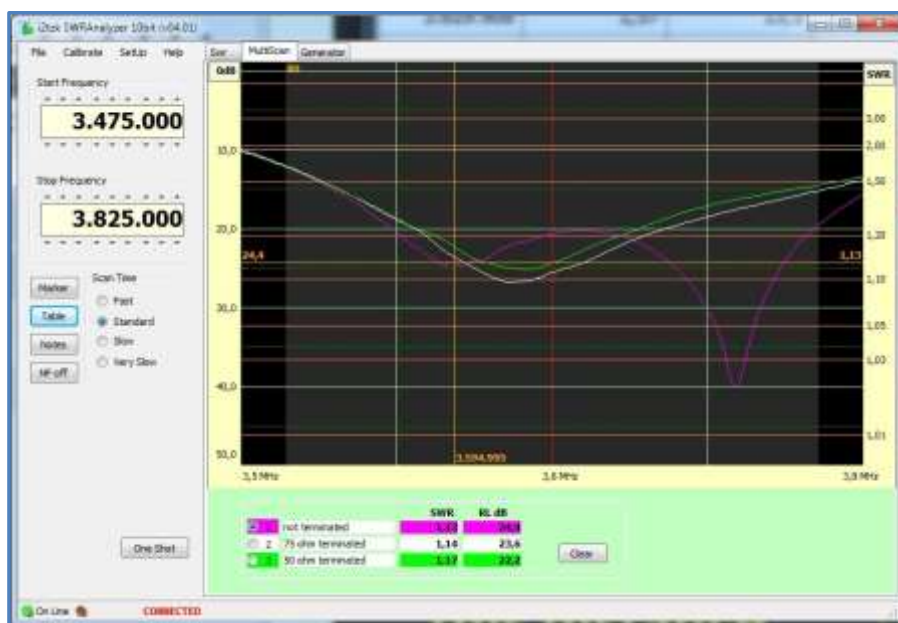

Figure on the left shows three channels being used to compares a pass-band filter response.

The generator was connected to one port of the filter and the other port initially left **open**, then terminated with **50 ohms** and **75 ohm s** loads.

8 Printing, exporting and importing data for analysis

The analyzer software allows you to print, export and import the results of your analysis.

Command: click on **[File]** on the Windows menu bar.

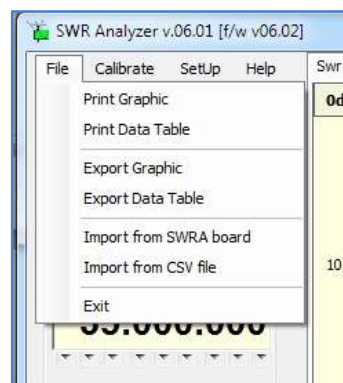

8.1 Print a Graphic

Command from Windows menu bar: **[File] [Print Graphic]** will open up a floating window as shown in the figure below.

There is an area where you can add a title for the print, and another window where you can add notes about the test condition.

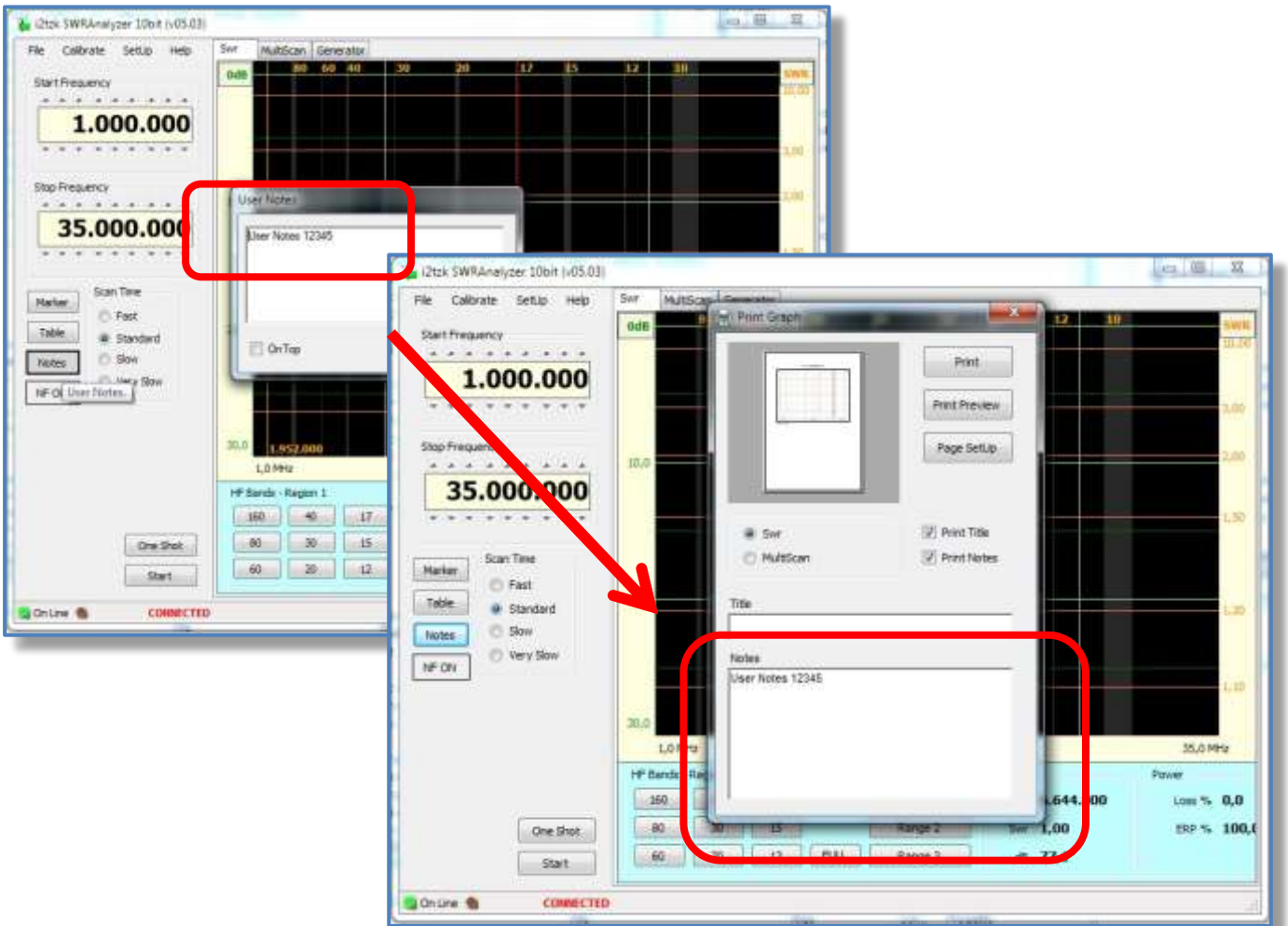

The figure on the right shows a PDF Print of a MultiScan plots of an 80m band-pass filter, titled:

“Return Loss and SWR Analysis, 80m band-pass filter”

with a user note:

“80m band pass filter response using different terminators”

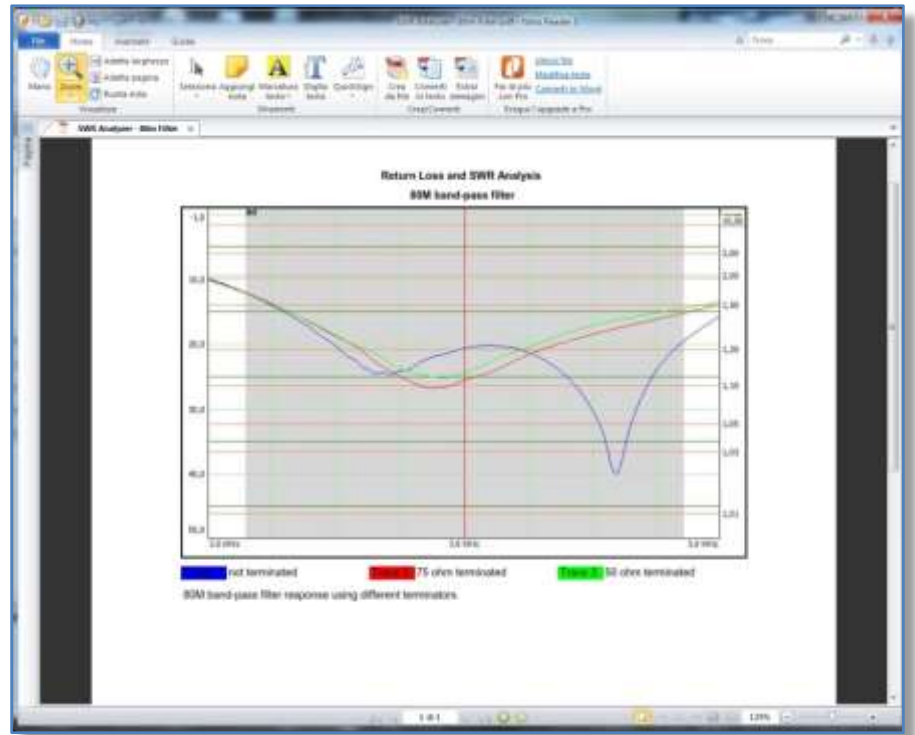

The same printing feature are available for the MultiScan page.

8.2 Print the Data Table

Command from Widows menu bar: **[File] [Print Data Table]**

Data collected during a scan analysis are organized into a Data Table, stored data can be shown pushing the button **[Table]** or printed.

Clicking on **[File] [Print Data Table]** pops up a new floating window where you can add a title to the data table being printed for future reference.

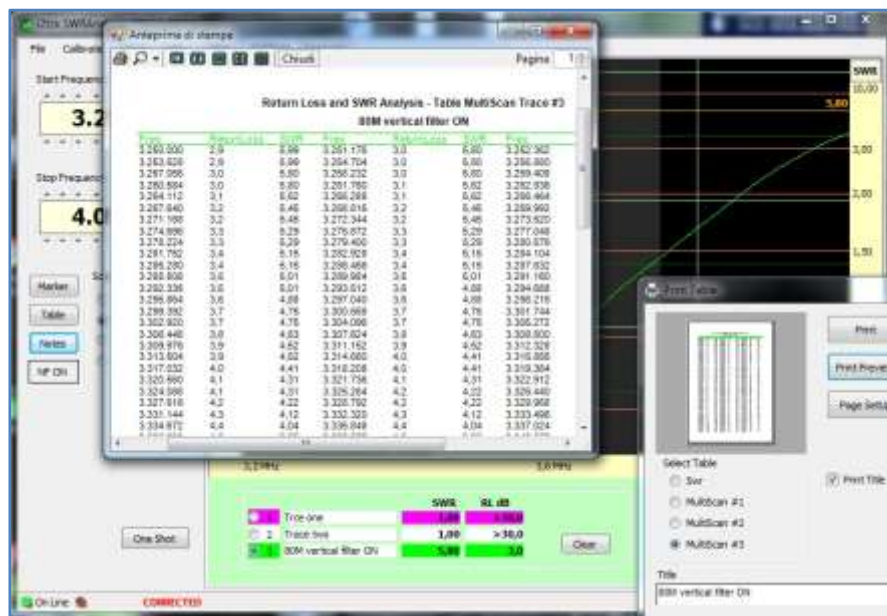

8.3 Export graphic as a picture

Command from Widows menu bar: **[File] [Export Graphic]**

The “Export Graphic” floating window offers three choices for the graphic export format: PNG, JPEG and BMP.

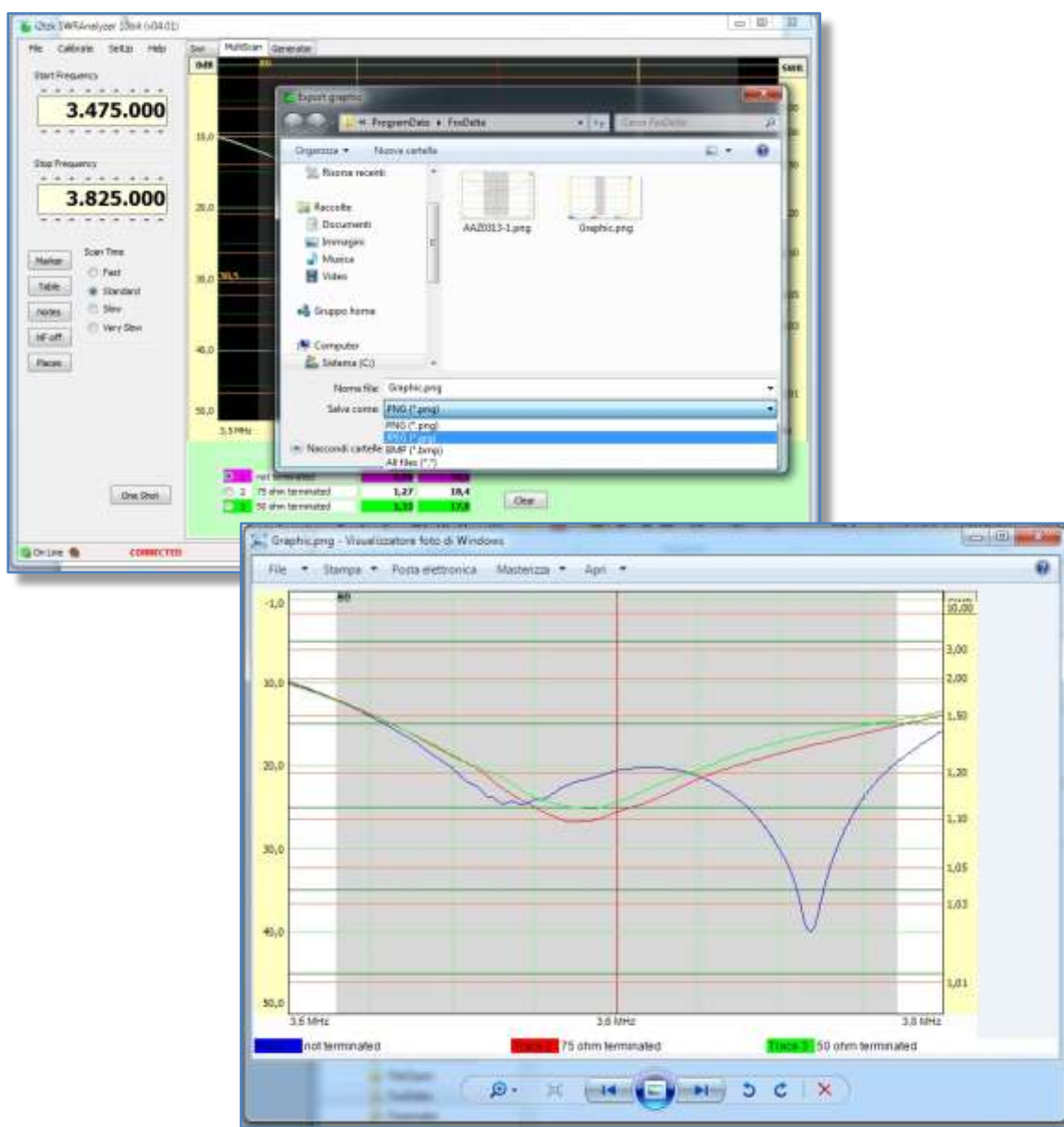

Save the file to any directory on the PC, but remember to name it so that it will help you identify the test conditions it relates to at a later date.

8.4 Export Data Table

Command from menu bar: **[File] [Export Data Table]**

A **CSV format** (Comma Separated Values) file containing “Frequency”, “SWR” and “Return Loss” of all Data Tables or a single Table is generated that can then be save in directory of your choosing.

The floating frame “Export CSV File” allows to edit/add the “User Notes” entered during the antenna scan process and to append those notes to the generated CSV file.

The screenshot shows the SWR Analyzer v.05.05 software interface. The main window displays a graph of SWR vs. Frequency. The 'Export CSV file' dialog box is open, showing the export file path as C:\ProgramData\FoxDelta\SwrTable Notes2.csv. The 'Export Notes' checkbox is checked, and the 'User notes' section is highlighted with a red box. The preview of the CSV file shows a table of data with columns for Frequency, SWR, and Return Loss, followed by a 'NOTES' section with user notes.

220	8000	100			
222	8000	100			
223	8000	100			
225	8000	100			
227	8000	100			
229	8000	100			
230	8000	100			
232	8000	100			
233	8000	100			
235	8000	100			
237	8000	100			
239	8000	100			
241	8000	100			
242	8000	100			
244	8000	100			
246	8000	100			
499	497	4045200	769		
500	498	4046800	764		
501	499	4048400	756		
502	500	4050000	749		
\$03	NOTES				
\$04	User notes				
\$05	first row of notes				
\$06	row number 2				
\$07	3 ...				
\$08	last row of user notes				

User Notes are appended to the end of the file, please notice the label “NOTES” (added by the export process) needed by the import program to identify where the unformatted text starts.

Values in the columns “Return Loss” (RL) and “SWR” are multiplied by 100.

When CSV file is imported into a spread sheet like MS Excel or other, able to read this format, for further analysis, a simple macro will help you to divide and round each value by 100.

ROW	FREQ	RL0	SWR0	RL1	SWR1	RL2	SWR2	RL3	SWR3
0	3475000	80	1	9,9	1,94	10,1	1,91	10,2	1,89
1	3475515	80	1	9,9	1,94	10,1	1,91	10,2	1,89
2	3476030	80	1	9,9	1,94	10,1	1,91	10,2	1,89
3	3476545	80	1	10	1,92	10,2	1,89	10,3	1,88
4	3477060	80	1	10	1,92	10,2	1,89	10,3	1,88
5	3477575	80	1	10,1	1,91	10,2	1,89	10,4	1,86
6	3478090	80	1	10,1	1,91	10,3	1,88	10,4	1,86
7	3478605	80	1	10,1	1,91	10,3	1,88	10,4	1,86
8	3479120	80	1	10,2	1,89	10,3	1,88	10,5	1,85
9	3479635	80	1	10,2	1,89	10,4	1,86	10,5	1,85
10	3480150	80	1	10,3	1,88	10,4	1,86	10,6	1,84
11	3480665	80	1	10,3	1,88	10,5	1,85	10,6	1,84
12	3481180	80	1	10,3	1,88	10,5	1,85	10,6	1,84
13	3481695	80	1	10,4	1,86	10,5	1,85	10,7	1,82
14	3482210	80	1	10,4	1,86	10,6	1,84	10,7	1,82
15	3482725	80	1	10,5	1,85	10,6	1,84	10,7	1,82
16	3483240	80	1	10,5	1,85	10,6	1,84	10,8	1,81
17	3483755	80	1	10,6	1,84	10,7	1,82	10,8	1,81
18	3484270	80	1	10,6	1,84	10,7	1,82	10,9	1,81

The CSV field separator is by default the punctuation mark “;” (semicolon).

Select from the menu bar **[Setup] [Advanced]** if you need to change it.

8.5 Import Data from SWRA board

Command from menu bar: **[File] [Import from SWRA Board]**

GLCD-CPU and Android terminal allow to save a scan analysis to the permanent memory of the SWR Analyzer, then the board can be moved to the PC and data recalled for a more detailed graphic analysis.

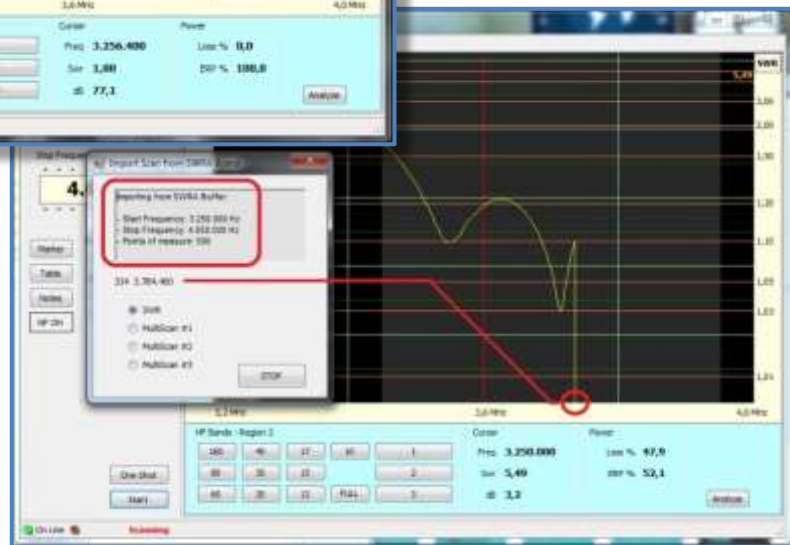
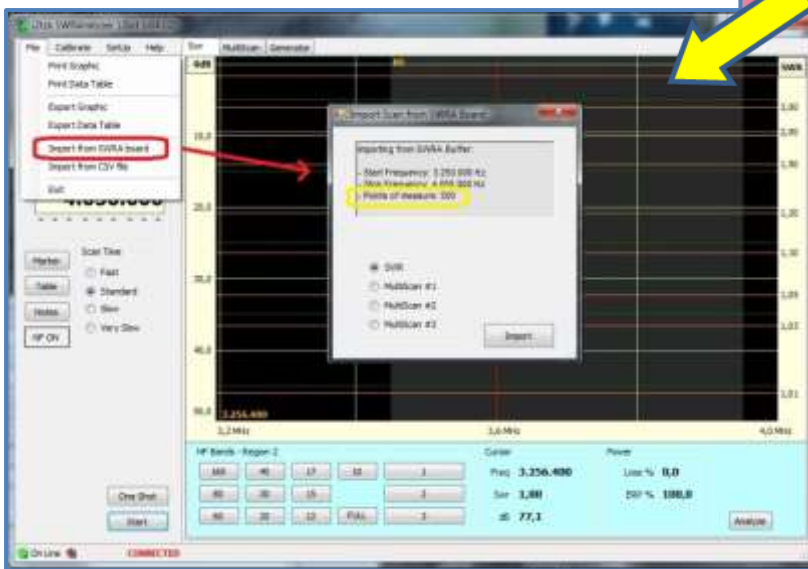

8.6 Import Data from a CSV File

Command from menu bar: **[File] [Import from CSV File]**

The **CSV file to be imported must have the same format as the CSV file generated by the Export function.**

The screenshot shows the SWR Analyzer v6.05 interface. The main window displays a table of data with columns for frequency, SWR, and other parameters. A dialog box 'Import CSV file' is open, showing the file path 'C:\ProgramData\FoxDelta\SwrTable NOTES.csv' and the destination table 'SWR'. A smaller dialog box 'Import Data Table' shows 'Data Table #0 successfully imported'. A 'User Notes' dialog box is also visible, containing text extracted from the CSV file. A red arrow points from the 'User Notes' dialog to the 'User Notes' section of the main data table.

Frequency	SWR	Power	Loss %	ERP %		
487	485	4026000				
488	486	4027600				
489	487	4029200				
490	488	4030800				
491	489	4032400				
492	490	4034000				
493	491	4035600				
494	492	4037200				
495	493	4038800				
496	494	4040400	788	235	8000	100
497	495	4042000	781	237	8000	100
498	496	4043600	776	239	8000	100
499	497	4045200	769	241	8000	100
500	498	4046800	764	242	8000	100
501	499	4048400	756	244	8000	100
502	500	4050000	749	246	8000	100

03 NOTES
04 User notes
05 first row of notes
06 row number 2
07 3 ...
08 last row of user notes

Before to start importing the file, program searches the file for User Notes (identified by the label "NOTES") and copies into the "User Notes" frame the text found

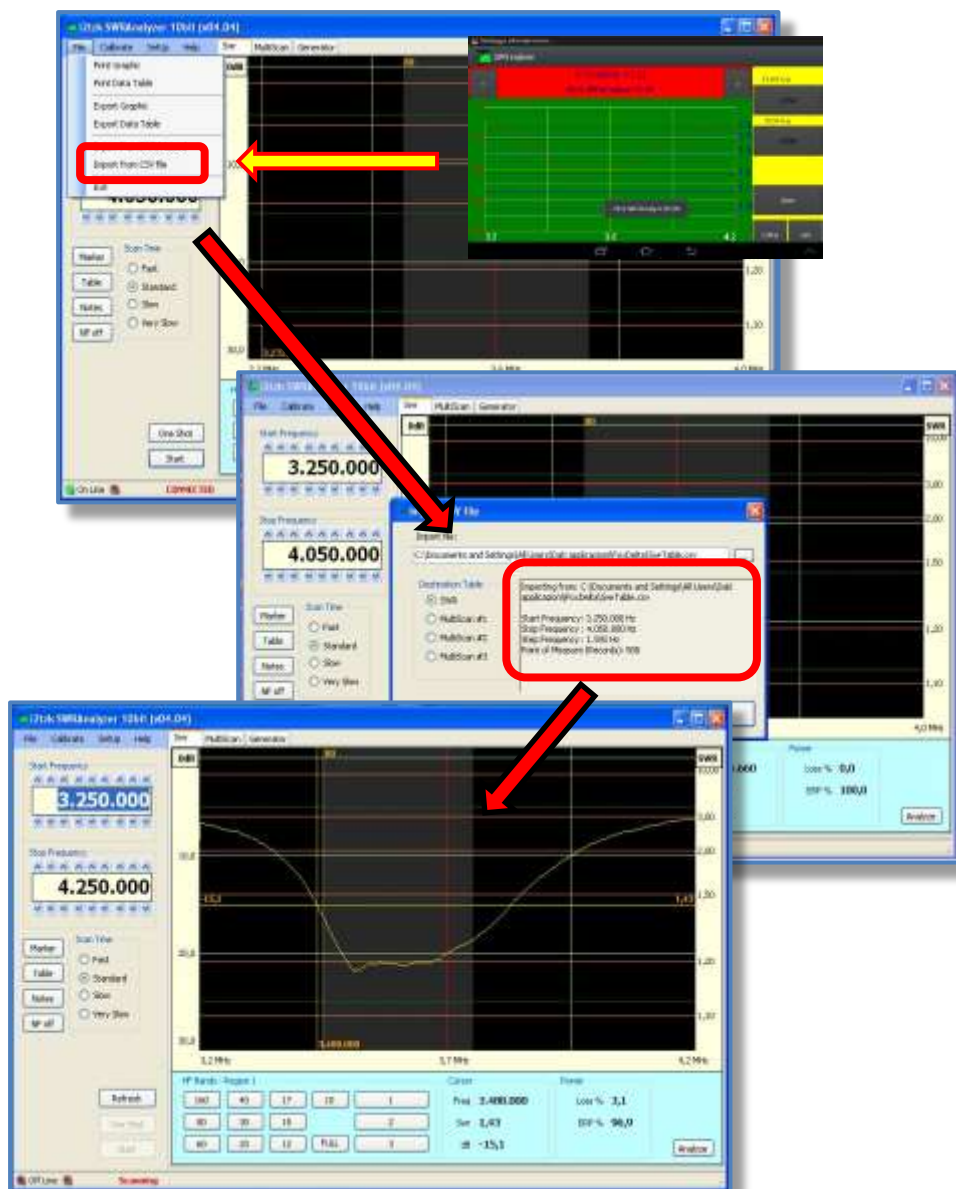

CSV file to be imported can be generated by the Android application (see figure) or by the “Export Data Table” function.

9 Signal Generator

Select this function from the menu bar by clicking on the **[Generator]** tab.

This opens a new window where:

- The generator frequency can be selected using the thumbwheels to a resolution of 1 Hz or pushing a button in the frame “HF Band”. This will initialize the generator frequency to the center of the selected band. Three additional buttons numbered “Frequency 1” ... are available for pre-defining custom frequency.
- The generator also has a SWR Bar graph reading, end of scale is selectable to 1:4 or 1:10. This enables you to tune an antenna or filter to a precise frequency.
- The SWR and return loss values are also displayed in larger easier to read font in two small frames at the top of the screen.

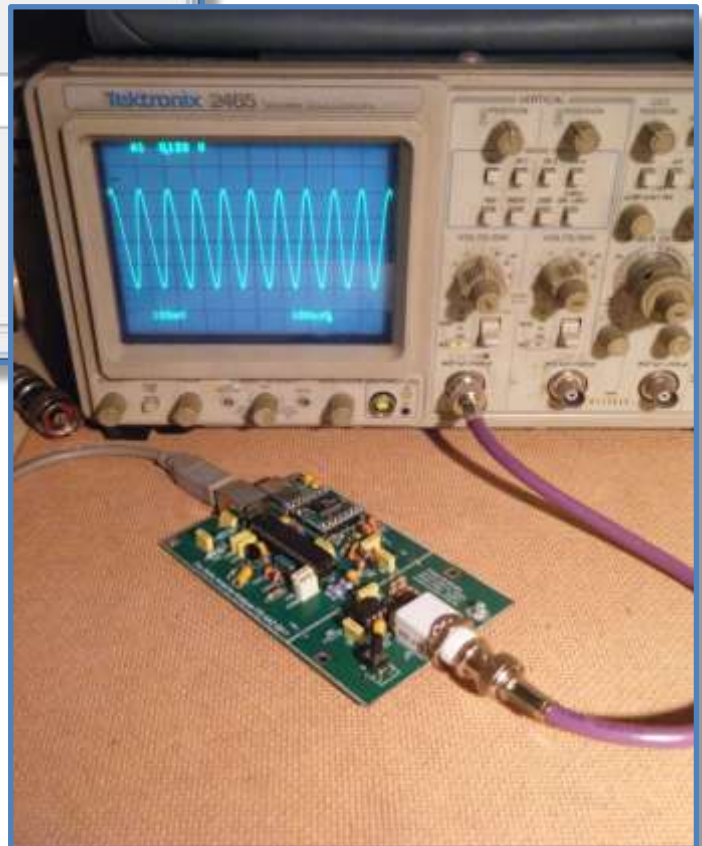
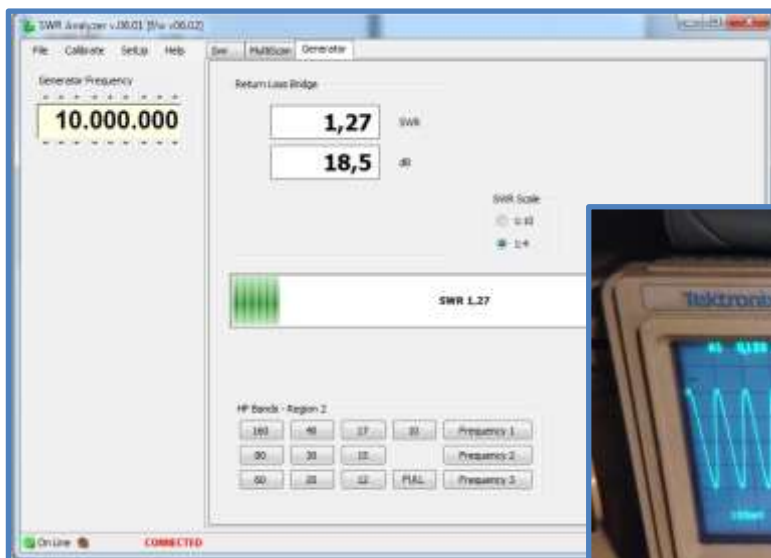

From the menu bar select **[SetUp]** and then in the new pop-up window select the **[Generator]** tab. The frame “HF Generator” allows to enter frequency and description of the three custom buttons.

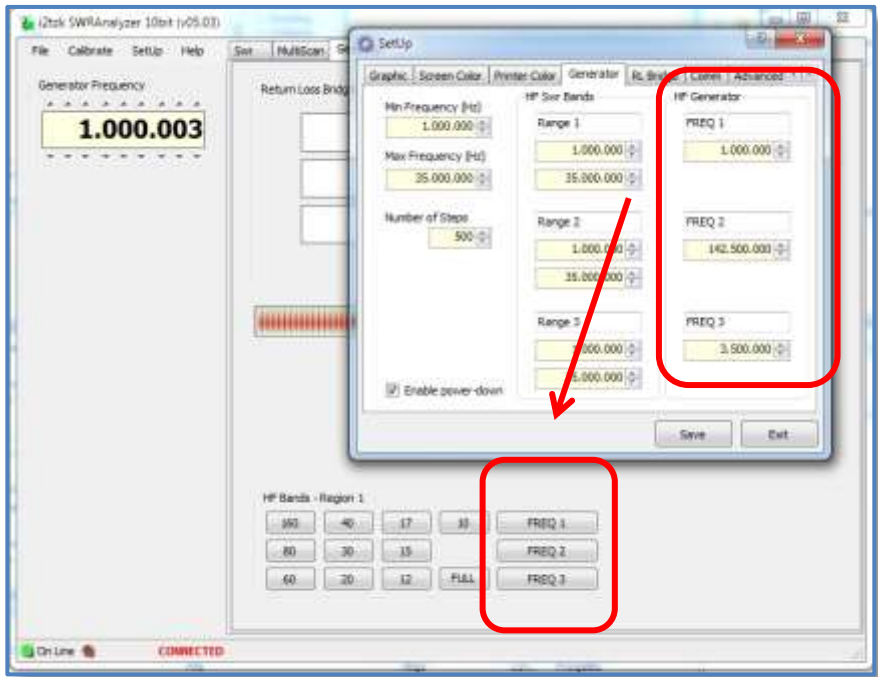

10 Special Applications

10.1 Characterizing a 50 ohm Filter

The procedure is to connect the Analyzer to one port of the filter and 50 ohms dummy load to the second port as shown in the connection diagram below..

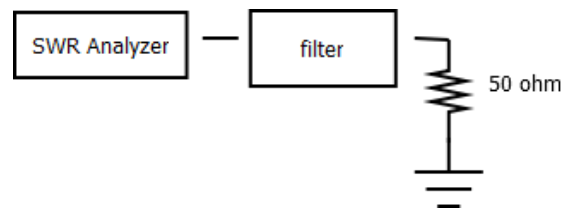

In the figure above the two ports are extended by 50 ohms coax, and the BNC Type dummy load in shown on the right connected to the “L” shaped bracket. It is important to have short and well-soldered terminations to obtain correct results.

METHOD 1

Select the [Generator] tab, and enter the centre frequency of the filter.

Tune the capacitors and or coils for a minimum SWR reading.

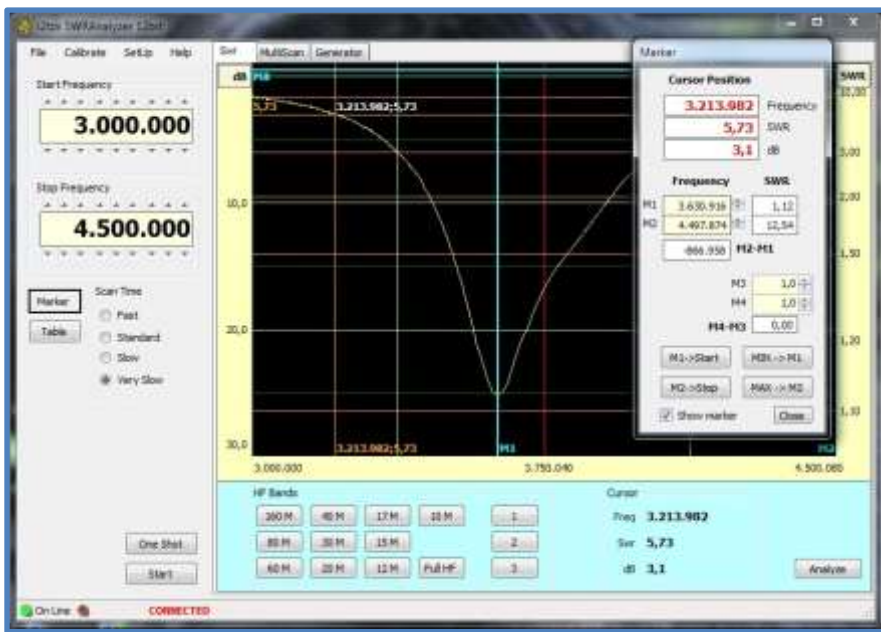
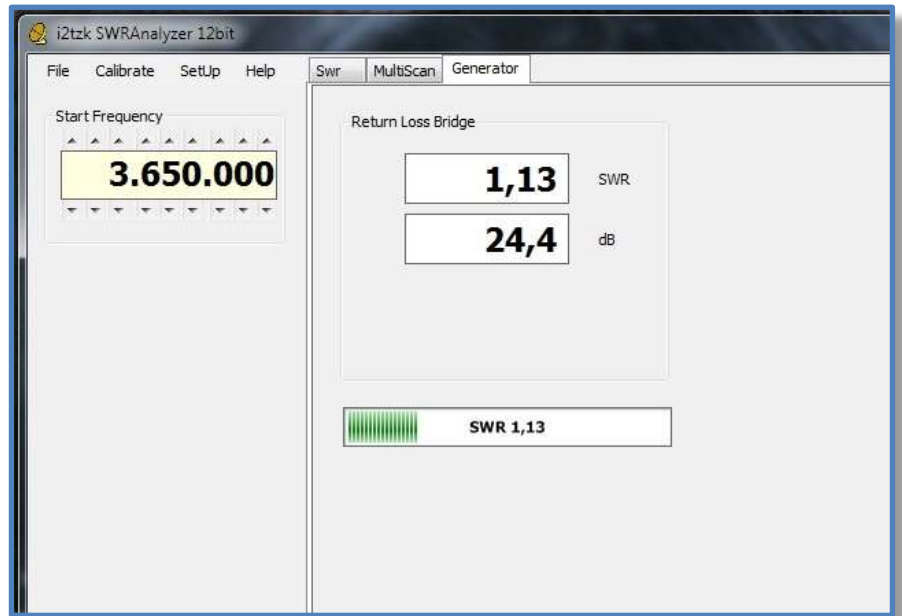

When filter has been tuned, select the [SWR] tab and select the band the filter works in, and click on **[One Shot]** to view a plot of the filters return loss.

Figure showing Return Loss of 80m band pass filter.

Click on the **[Analyze]** button to display the resonance parameters in the pop-up window.

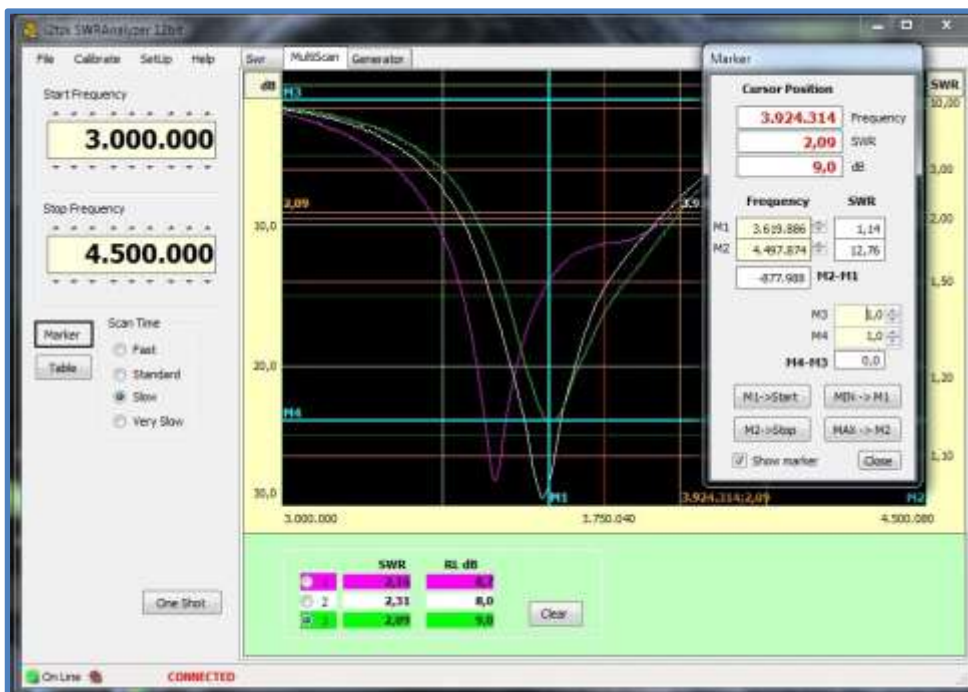
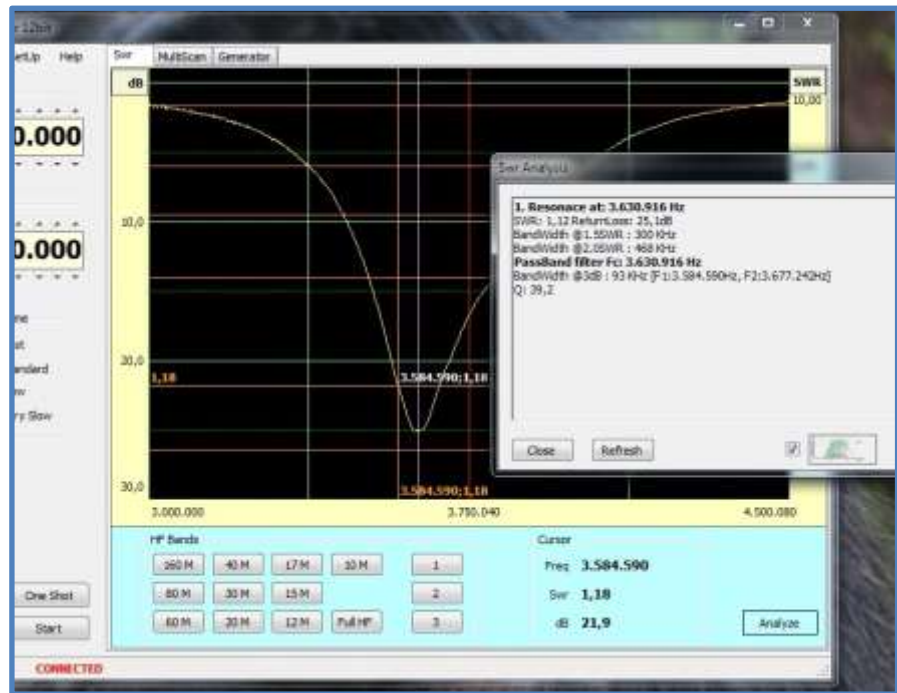

METHOD 2

Use the **[MultiScan]** tab and select channels so that you can compare the effect of altering the values of individual capacitor or coils.

For a precise plot use a low scan rate

10.2 Matching the Antenna Tuner to the Antenna

This Analyzer is used to replace the transceiver, the [Generator] is selected by clicking on the tab, and using the thumbwheels, the required frequency is set. The tuner is adjusted while observing the displayed SWR bar graph. Adjust the control settings of the tuner to obtain a minimum SWR.

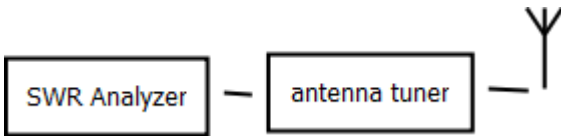

Matching the MFJ-902 at 14.195 MHz

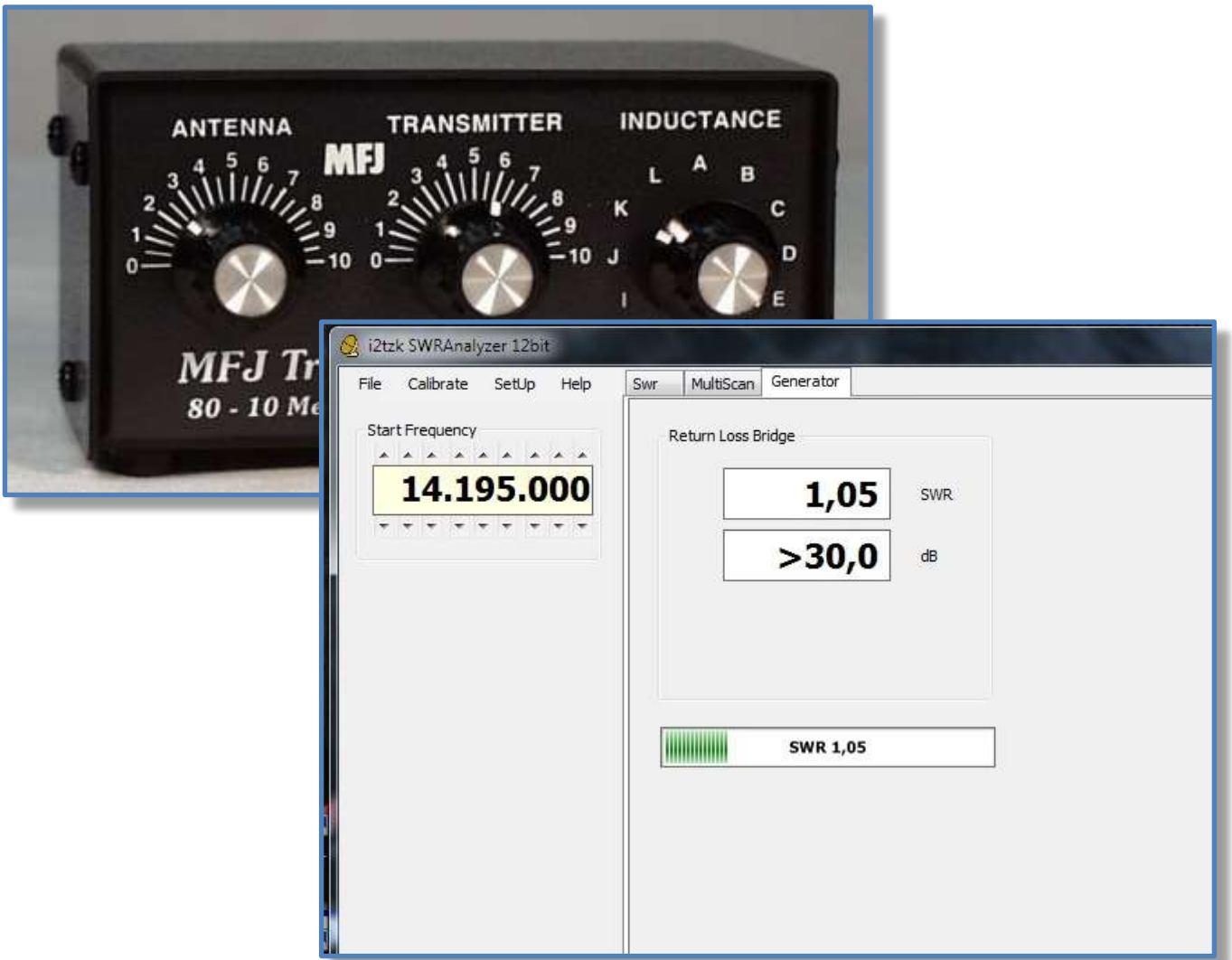

10.3 Data gateway

A very simple **UDP client/server** feature has been implemented, this is able to:

- Export real time data to a second program (windows).
- Respond to simple commands.

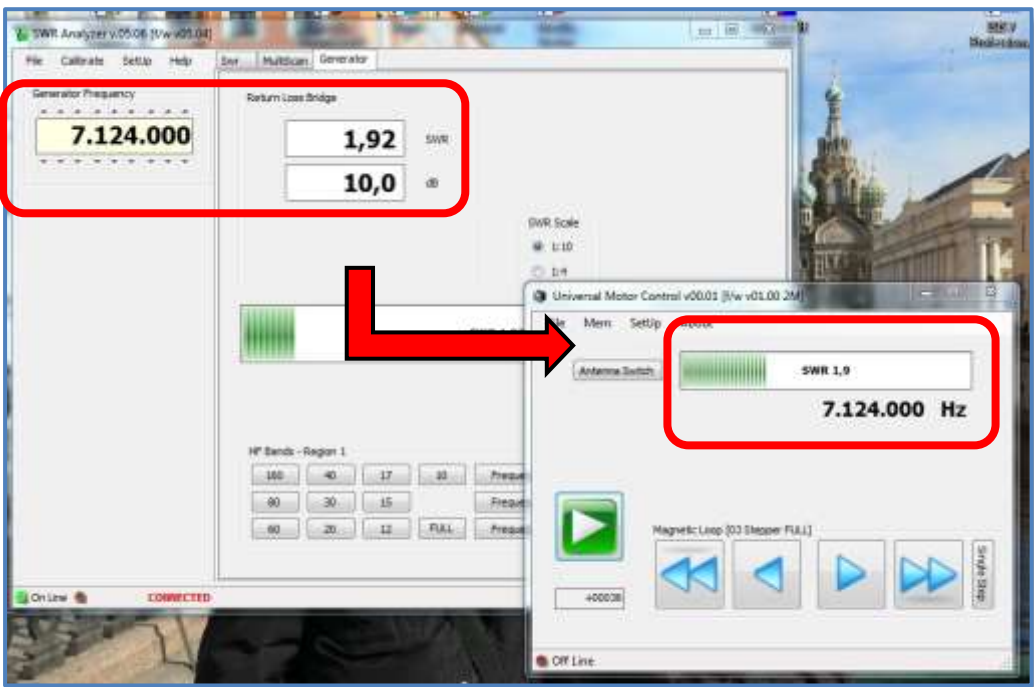

UDP client/server is active only on the "Generator" window.

Select **[SetUp][Comm]** to enable the UDP communication channel.

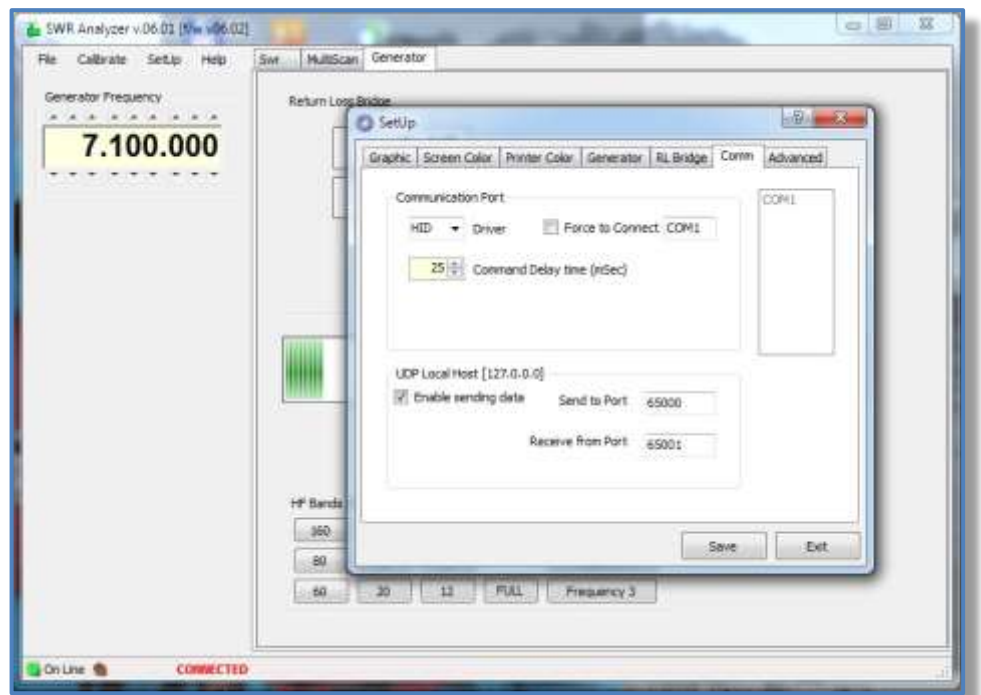

11 Firmware update

The SWR Analyzer AAZ-0914 unit is based on Microchip's PIC18F2550 28DIP chip, the component's kit provided by FoxDelta includes the microprocessor programmed and ready to work.

The firmware implements a special function (bootloader provided by Microchip) that is used to update the 18F2550 with new firmware version via the USB port, **no external pic programmer is required.**

Please refer to: <http://www.microchip.com> for details about the hex code linked to the SWRA firmware, or any further information and their copyright notice.

To **program from scratch** the flash memory of the 18F2550 a **pic programmer is needed**, please burn the file: **Swr Analyzer vX.XX FULL.hex** included in the f/w releases. This file also includes an embedded copy of the bootloader code.

To verify the current installed version
select from the menu bar:
[Help][About]



Latest firmware release is available here: <http://www.i2tzk.com>

The firmware updating procedure requires to:

- Execute the Windows bootloader program
- Activate the SWR Analyzer "Update Mode" and connect it
- Update the firmware

11.1 The updating procedure

The program “HIDBootLoader.exe” (provided by Microchip) is used, this is the Windows interface to access the bootloader function and flash the microprocessor memory.

- Download from the Microchip website <http://www.microchip.com> or from the FoxDelta server the bootloader program.
- At present, last available release is named: “Microchip Bootloader 2.90a.zip”
- Create a temporary folder and unzip there the file “Microchip Bootloader 2.90a.zip”:
 - HIDBootLoader.exe
 - libgcc_s_dw2-1.dll
 - mingwm10.dll
 - QtCore4.dll
 - QtGui4.dll
- Download from the FoxDelta server the last version of the f/w you want to update and copy on the folder created above the file “..... **UPDATE**.hex”.

For example: **SWR Analyzer v6.01 UPDATE.hex**

- Remove the USB cable connecting the FoxDelta hardware
- Navigate to the folder where the program “HIDBootLoader.exe” has been unzipped and launch it.

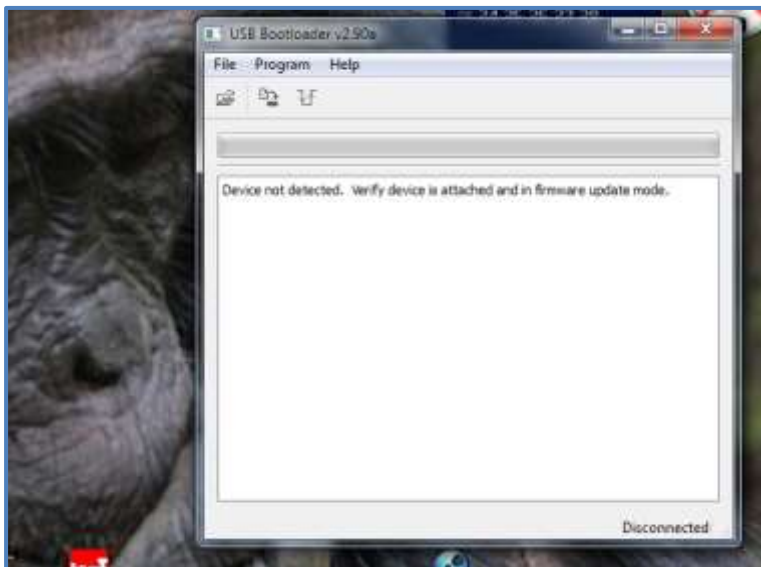

Notice:

All buttons are disabled.

Message: “Device not detected.....”
is presented.

- **Activate the “update mode”** shorting the header “UPDATE” located next to the processor then connect the AAZ-0914 board to the USB port.

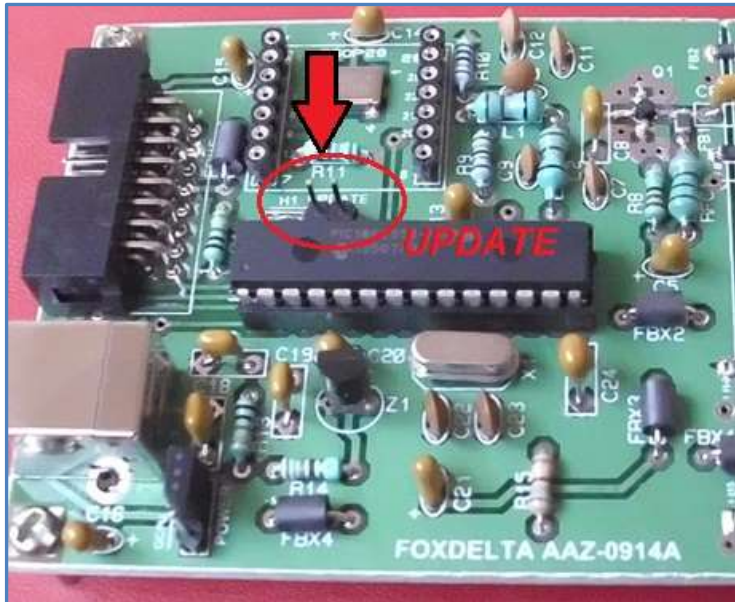

Notice:
The header “Update” must be **shorted before** to connect the USB cable.

After a while, the USB Bootloader program identifies that the AAZ-0914 is ready to be programmed and the message **“Device Ready”** appears, menus and buttons are enabled.

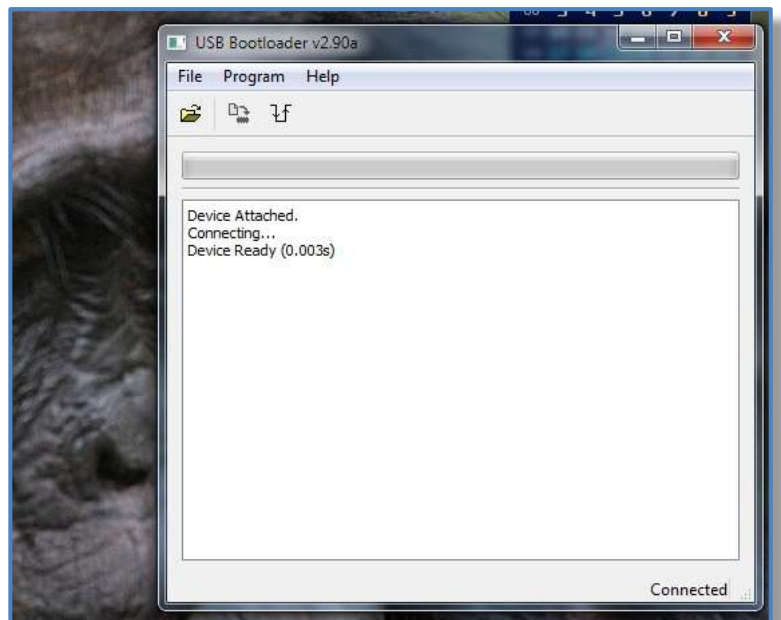

- Select from the menu bar: **[File] [Import Firmware Image]**, navigate to the folder where the new firmware hex file has been unzipped and select it.

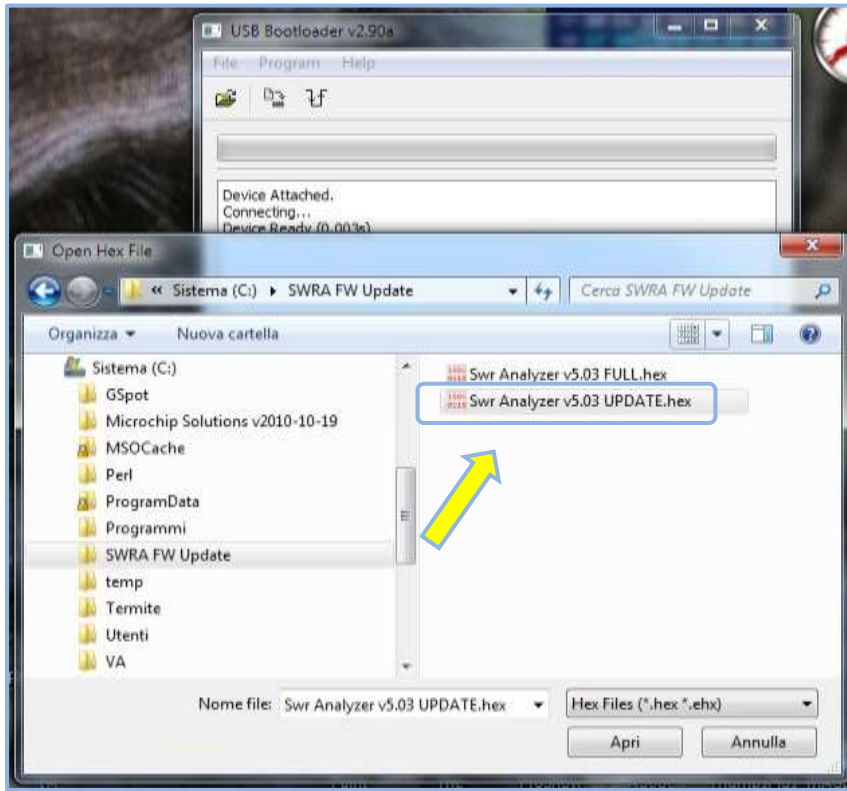

Be aware of the **UPDATE** file selection.

- Verify that in the floating panel **[Program] [Settings]** the options: “FLASH Program Memory” and “EEPROM” are checked.

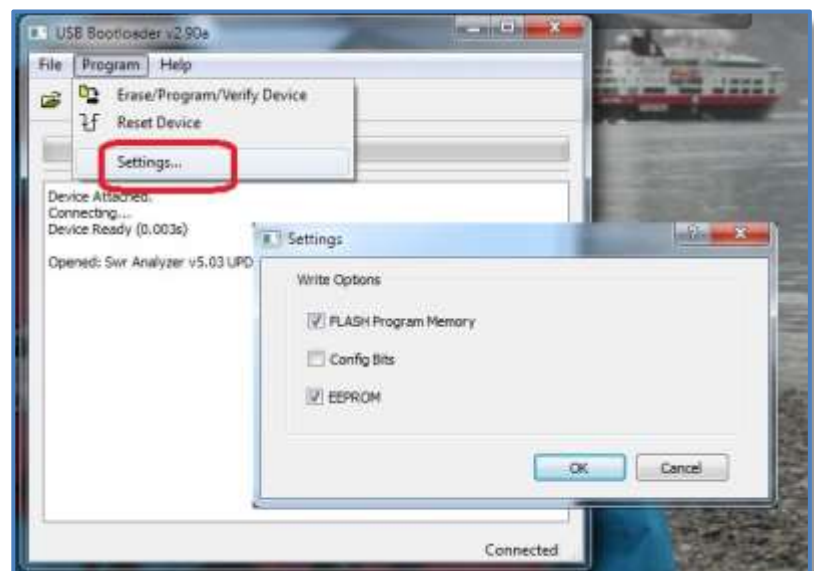

- Select from the menu bar **[Program] [Erase/Program/Verify Device]**, the updating process starts and a green bar shows the progress.

Do not remove the USB cable or power off the SWRA AAZ-0914 unit during this step.

**Please WAIT for the message:
“Erase/Program/Verify Completed Successfully”**

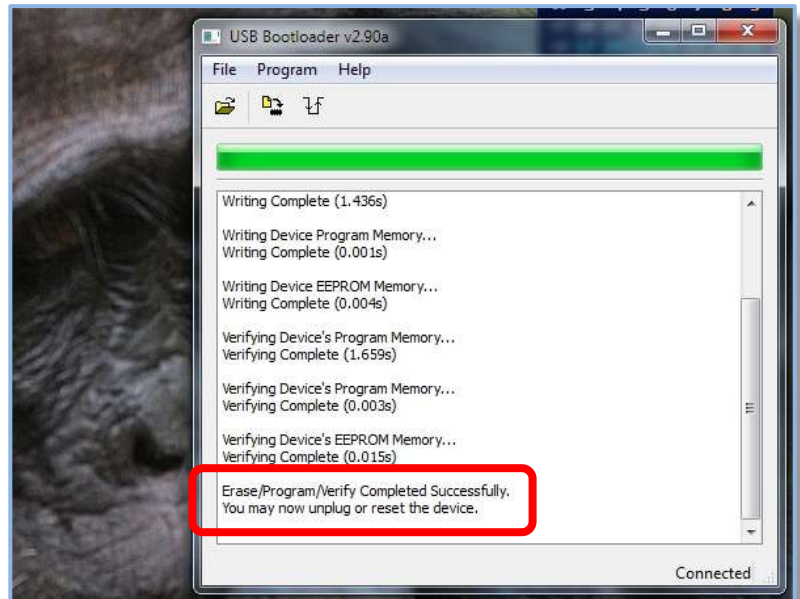

- The SWR Analyzer unit is now updated, **do not forget to remove the jumper “Update”**.
- Exit the update function selecting **[Program] [Reset Device]** or unplug and plug again the USB cable.
- Verify that the new f/w has been installed and it is properly working.

12 Hardware implementation

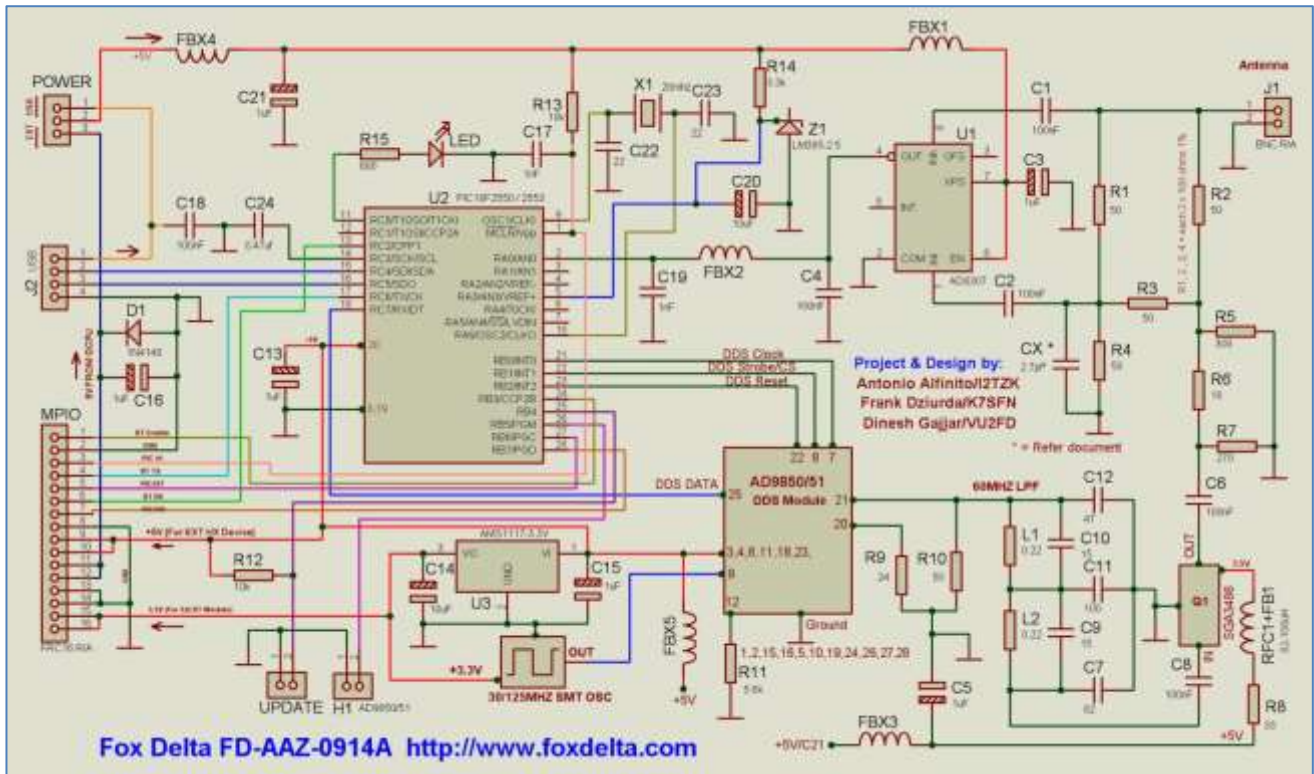

The circuit diagram (FD-AAZ-0914A) of the SWR-Analyzer

Please refer to: <http://www.foxdelta.com/products/aaz.htm> for more details about the hardware documentation and available kits.



Also look in the "Builder Gallery" at <http://www.i2tzk.com>

12.1 DDS

Two Analogue Device DDS Synthesizer chips are supported:

- AD9850 125 MHz Clock Rate
- AD9851 180 MHz Clock Rate

Please notice that the highest frequency you can get is half of reference **Oscillator Clock 125MHZ**, this means about 60MHZ.

Please connect the pic pin26 to GND (header H1) when the AD9850 is installed.

12.2 Led

LED blinking code	
Led ON	USB cable is plugged in, HID device is recognized and driver loaded by Windows. SWRA.exe program is not running.
3 fast flash	SWRA board has been recognized and connected by the SWRA.exe Windows program
continuous fast flash	A scan cycle is running

13 SetUp Procedures

13.1 SWR and Return Loss Scaling

By default the program sets this to SWR 10:1 max and 1.2:1 min / Return Loss -6.0dB to 20db.

Note: the loss is a positive number.

SWR / dB scale:
Max = 20
Offset = -6

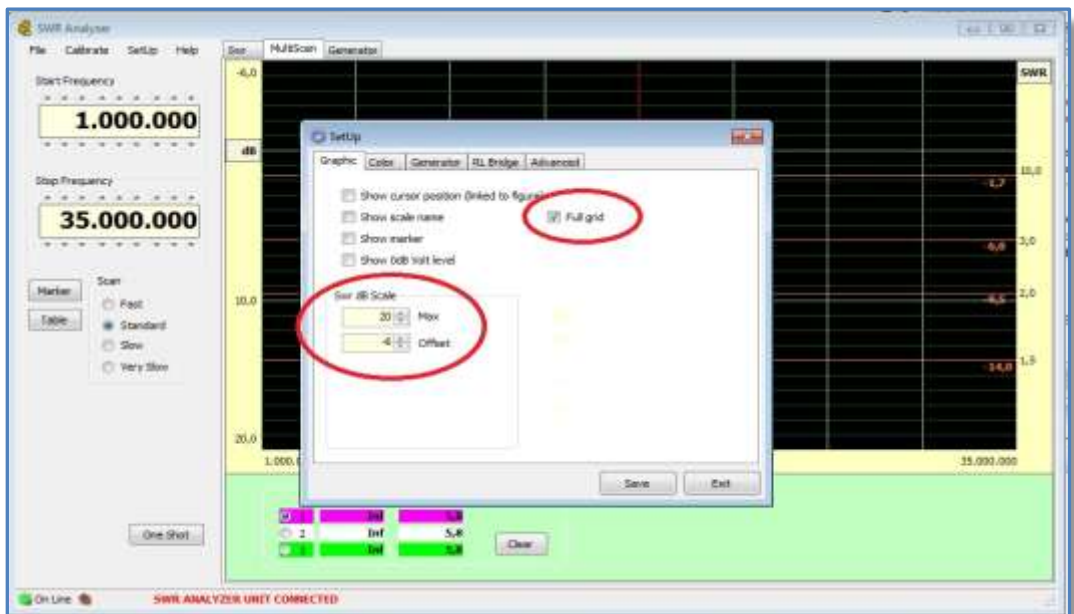

- **The SWR Analyzer should already be calibrated**
- To Customize the graphic scales from the Windows menu bar select **[SetUp] [Graphic]**. In the pop-up window use the numeric up-down controls to set the max and offset Return Loss dB scale. The SWR scale is set automatically from these values.
- Save and restart program.

13.2 Open/Short ratio check of the RL Bridge

- On the **[SWR]** Tab click on FULL HF button first to set the scan to cover 1-35MHz.
- Next select the **[MultiScan]** to carry out the Open/Short ratio checks of the RL Bridge
- Select the graph #1 (fuchsia) , connect a 0 ohm terminator (short circuit) and click on the **[One Shot]** button
- Next select the graph #2 (white), remove the short to leave the RL Bridge open and click the **[One Shot]** button again.
- Now look at the two traces and the gap between them as shown in the next figure

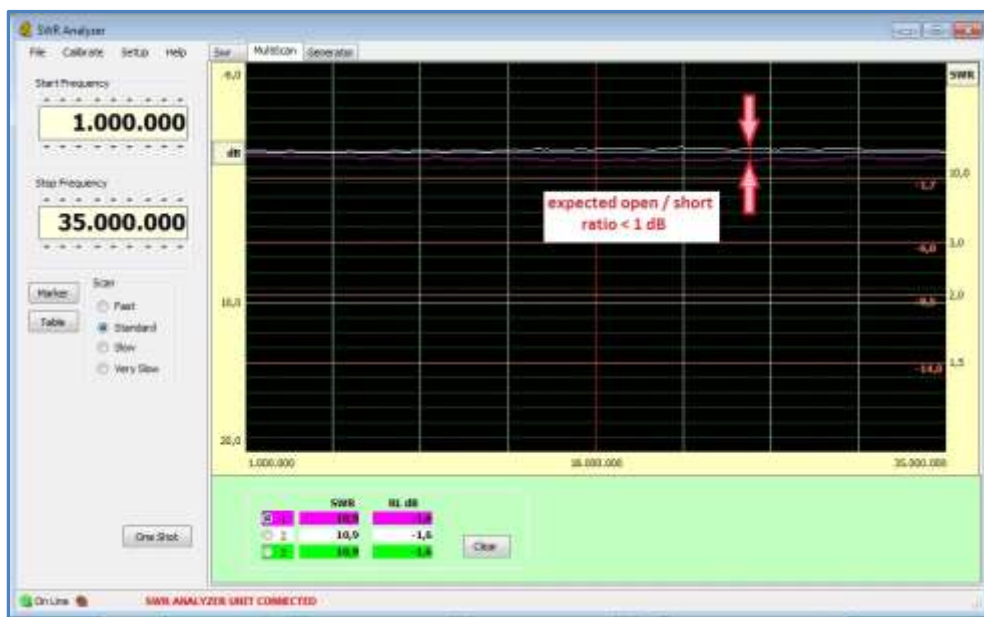

The dB difference of 2 horizontal traces across the whole HF bands, measures the Open/Short ratio.

The Open/short ratio is expected to be less than 1dB across 1.0MHz - 35MHz

13.3 Checking the RL Bridge accuracy

- **Ensure the SWR Analyzer calibration procedure has been carried out.**
- Change the graph scales by selecting the menu **[SetUp]** and **[Graphic]** tab on the floating window.
- Set the “SWR dB scale” to Max = 60 and Offset =20

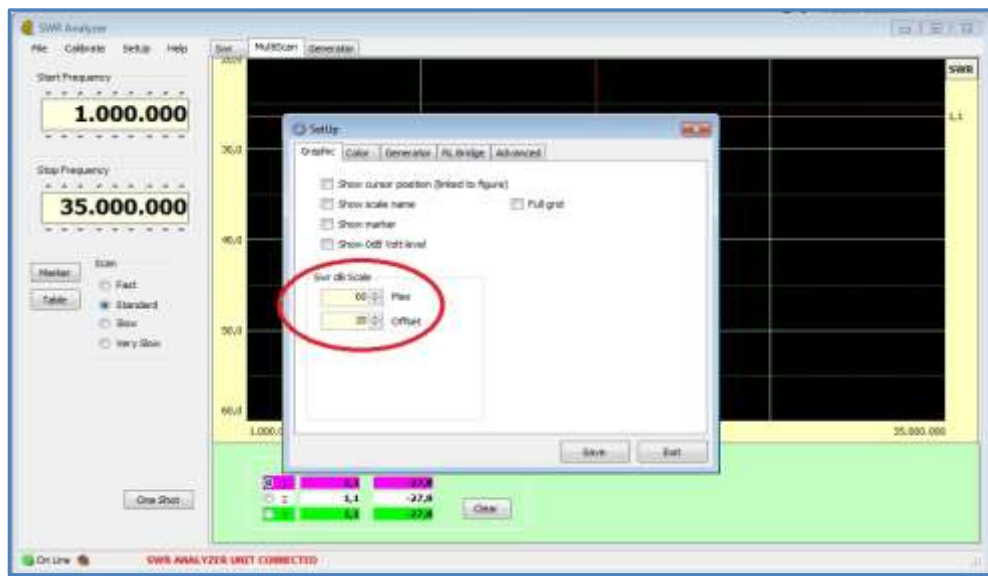

- Click on the **[Save]** button and restart program.
- After the program restarts the graph scales will change to the new values.
- Select the **[MultiScan]** tab.
- Select any graph (1-3) and connect a 50 ohm terminator and click on **[One Shot]** button to start a scan.
- The trace should lie close to the scale line SWR= 1.0 across the whole of the 1.0—35MHz .
- This will prove that the Return Loss Bridge is functioning correctly.
- You may wish to repeat the exercise using different termination resistances

N.B. A 25 ohm terminator (two 50 ohms terminators connected to a “T” adaptor) will show a 2:1 result. A 200 ohms or 12.5 ohms resistor will show an SWR reading of 4:1



Figure above shows the results for a variety of different terminations.

The expected accuracy is better than 30dB depending on the quality of the 50 ohms terminator

13.4 RL Bridge minor calibration adjustments

The trace for a 50 ohms purely resistive termination should be a horizontal “flat” line, but parasitic capacitances of the BNC, printed circuit board layout and self-inductance of the bridge resistors can cause the trace deviate from the horizontal.

Any deviation over 30dB loss is not important, nevertheless it can be compensated by adding a very small capacitor in parallel to the BNC connector. See the figure below a 2.2pF capacitor is circled in red.



The 50ohm terminator line has been flattened showing a slight variation over the whole HF spectrum; 40.5dB 2 dB @1MHz and 38.5dB @35MHz

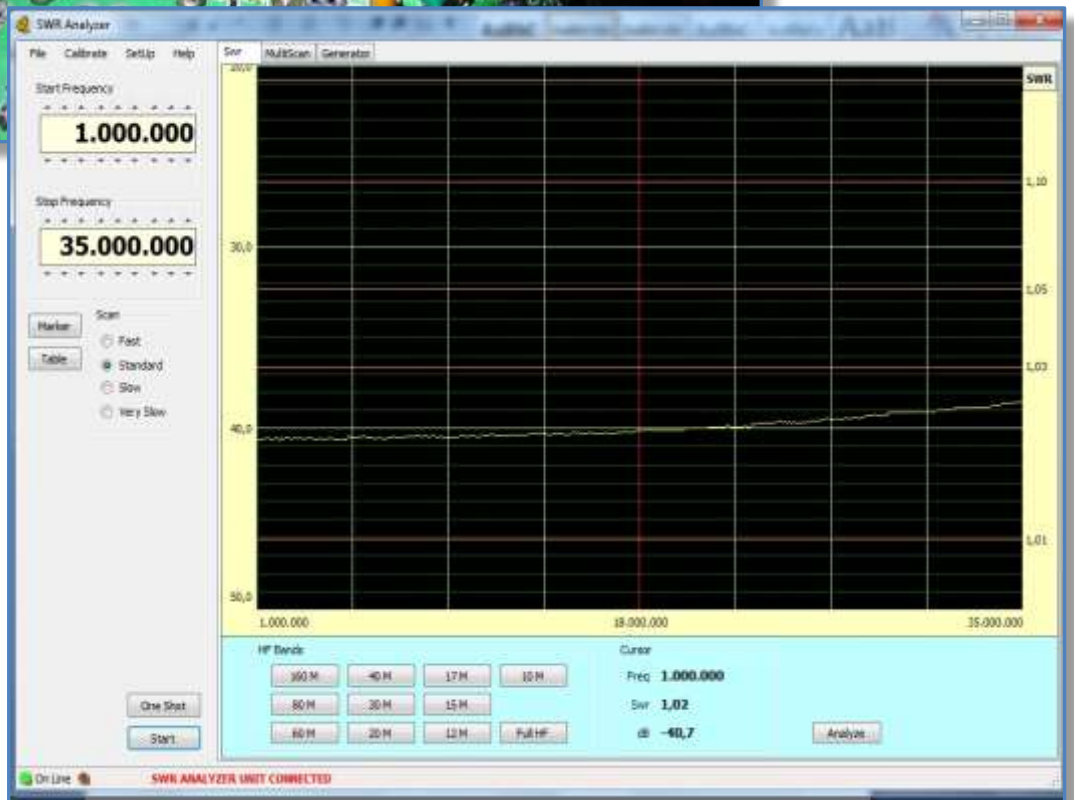

14 Optional add-on

The AAZ-0914A SWR Analyzer hosts a FRC16 connector designed to expand the Analyzer's features.

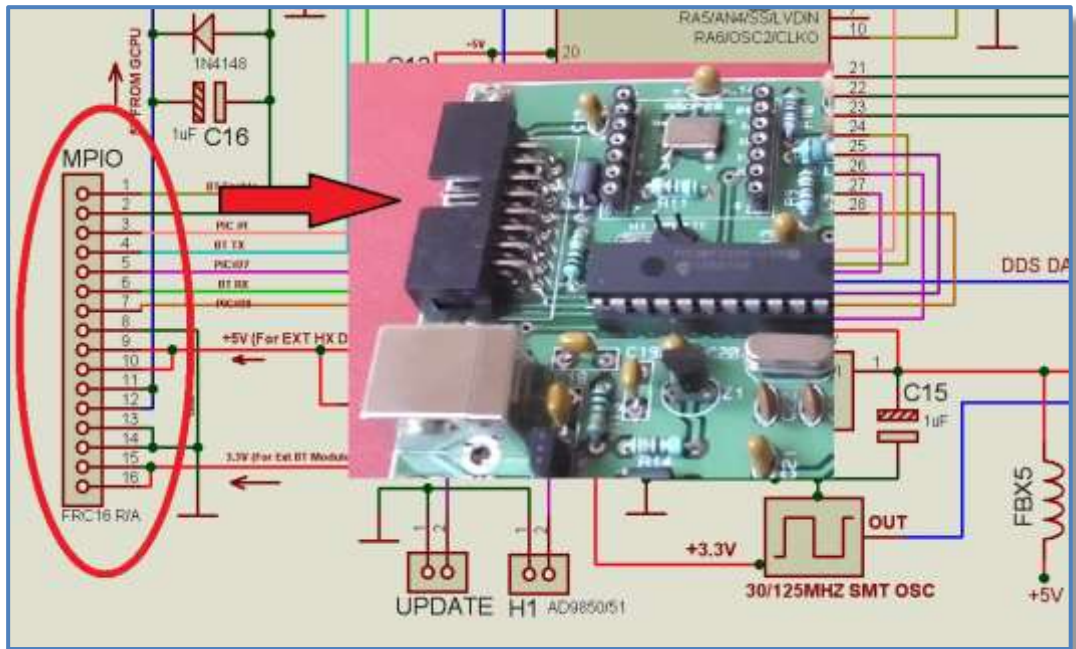

Please visit www.foxdelta.com for the complete list of available add-on kits.

14.1 Bluetooth module

This add-on board allows AAZ-0914 SWR Analyzer to connect a portable Android terminal or a Windows laptop via a Bluetooth link instead of the USB port.

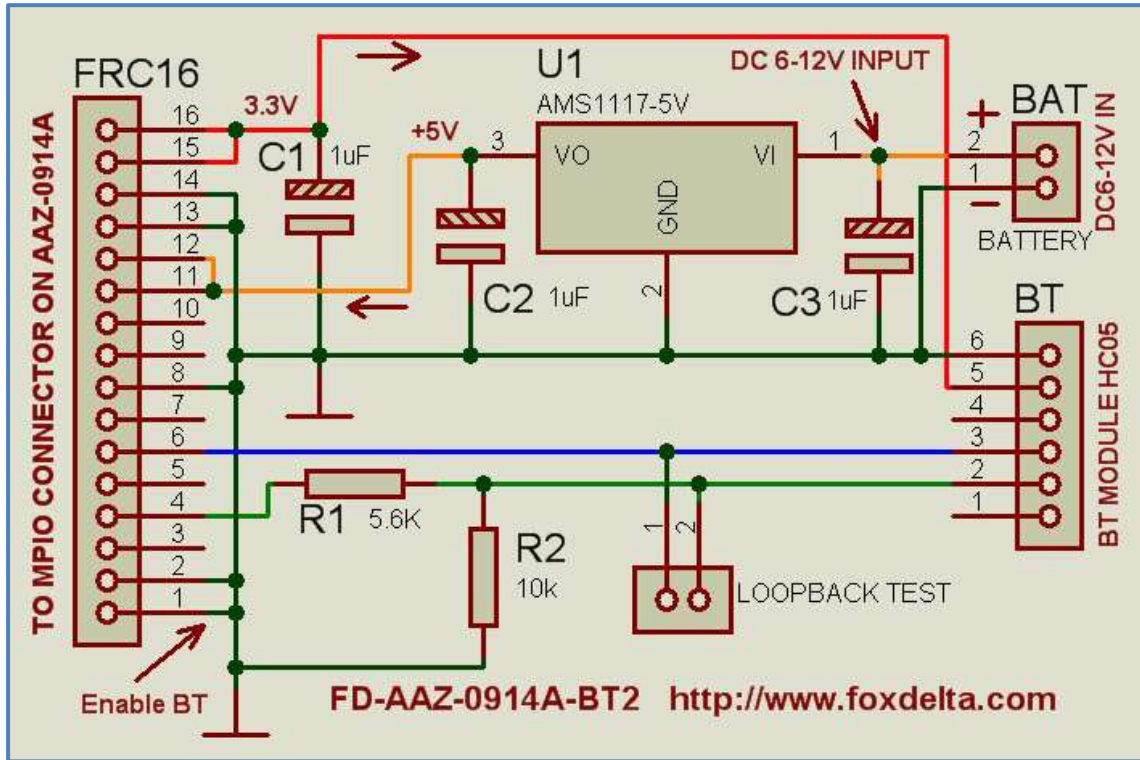

The Bluetooth Module can be powered from AAZ-0914A and it is automatically recognized by the firmware that disables the USB port and activates the Bluetooth communication channel.

While using Bluetooth function, it is assumed that the USB power is not available and external power will be required to power AAZ-0914A and BT module. This is achieved by providing Battery Connection on this board. DC 6 to 12V may be applied to power AAZ and BT module.

Please refer to www.foxdelta.com for the detailed description of this unit, to “SWR Analyzer - Android User Guide” and “SWR Analyzer - Add-On User Guide” for any detail about Android and PC initialization for working with SWRA and Bluetooth.

14.2 GLCD for stand-alone operations

This small breakout board kit is needed if you want to *analyze the antenna without using the PC*, the GCPU unit displays the resonance curve on a Graphic Stand-Alone LCD.



Please refer to www.foxdelta.com for the detailed description of this unit.

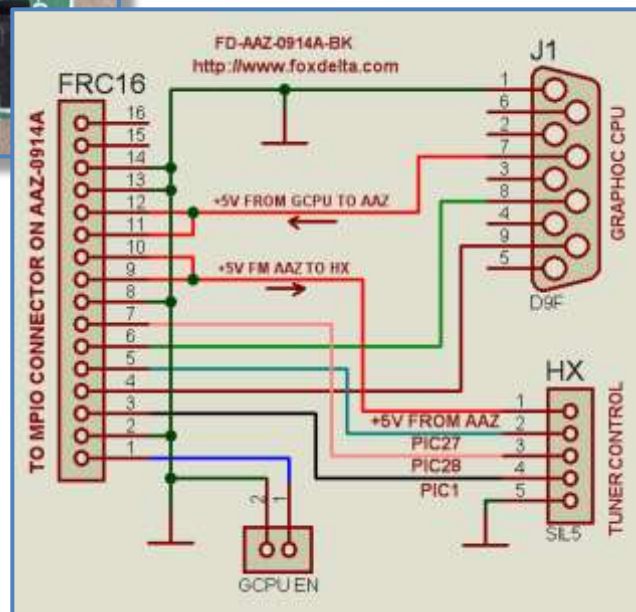

Following pictures show the Graphic LCD/CPU (GCPU-0613)

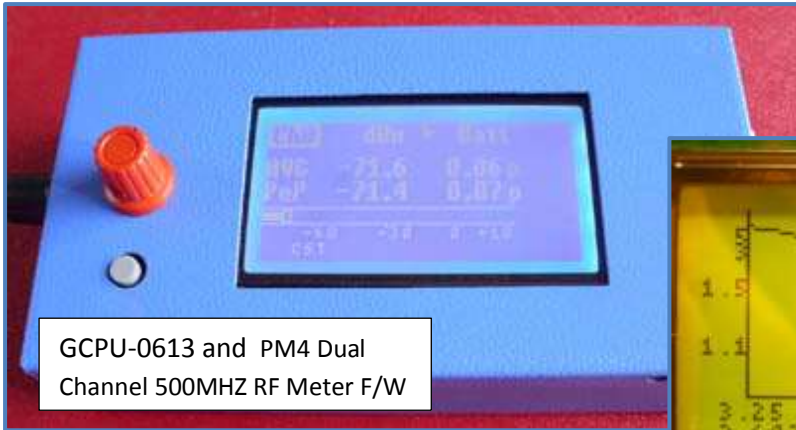

GCPU-0613 and PM4 Dual Channel 500MHZ RF Meter F/W

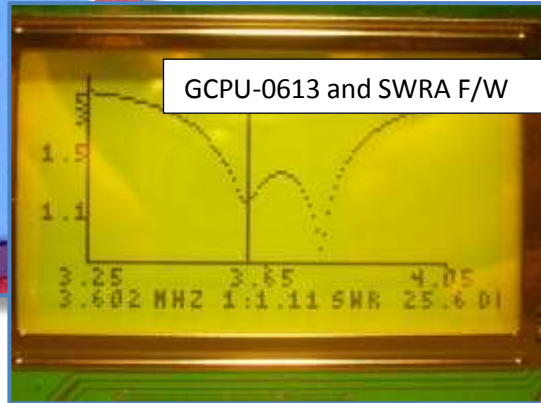

GCPU-0613 and SWRA F/W

Please refer also to the paragraph **“Import Data from SWRA board”** and to the document **“SWRA GLCD: measuring without PC”** for more details.

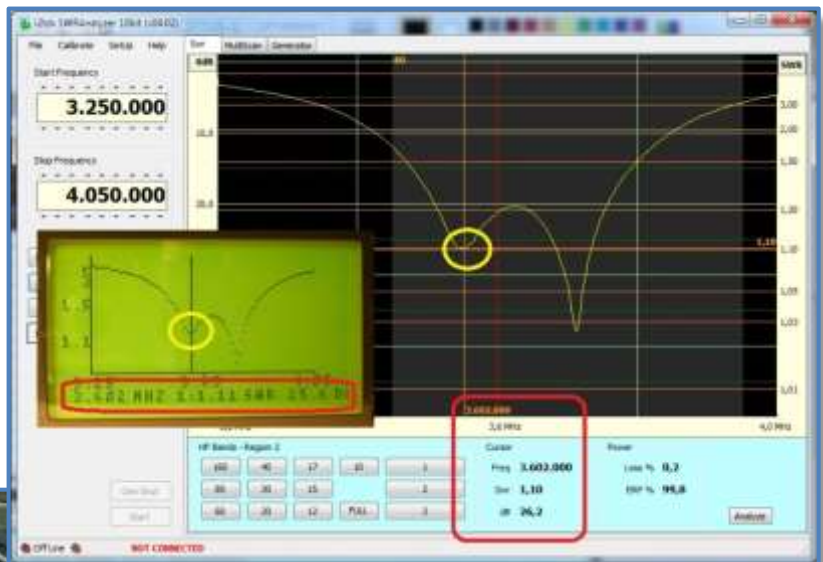

GCPU-0613 and AAZ0713 running a standalone analysis.

15 Help menu

From the menu bar the **[Help]** tab allows to quickly access to:

- This User Manual
- “What is new” documents
- Identify the software and firmware versions

To access the User Guide **[User Manual]**, this document must be renamed “**SWR Analyzer Guide.pdf**” and copied to the same folder from where SWR Analyzer.exe is running. Please cfr the paragraph “Launching the PC program”

In the similar way to access **[What Is New]**, rename “**SWR Analyzer What Is New.pdf**” the document listing the new available releases features and copy to the same folder from where SWR Analyzer.exe is running.

The **[About]** command popups the following floating window where to read current f/w and s/w versions:

